

## **Design Guide** **Self-regulating trace heating systems** **for hazloc / industrial applications**



### **Design guide**

BARTEC Self-regulating trace heating systems  
for pipes and tanks in hazardous locations  
with BARTEC Self-regulating trace heaters



<b>Table of contents</b>	
<b>Overview</b>	<b>2</b>
Applications	3
Technical data	3
Certifications / Approvals	3
Safety	3
Personnel requirements	4
<b>System design</b>	<b>5</b>
Trace heater selection	5
Determination of the required trace heater length	13
Determination of the required number of heating circuits	14
Selection of the required components for power connection, control and monitoring, end termination etc.	16
Trace heaters	22
Power connection, splice and junction components	23
Control and monitoring units	24
End termination	25
Accessories	26
Spare parts	29
<b>Installation</b>	<b>30</b>
Preparation	30
Required tools / equipment	31
Unrolling the trace heater	31
Installation on pipes	31
Fastening	32
Trace heater routing	32
Installation on tanks and vessels	34
<b>Tests and commissioning</b>	<b>36</b>
Measurement of the insulation resistance	36
Acceptance test and acceptance test report	37
Commissioning	37
<b>Operation</b>	<b>37</b>
System documentation	37
<b>Maintenance</b>	<b>37</b>
Visual and functional inspection	37
Electrical inspection	38
Inspection intervals	38
Personnel training courses	38
Repairwork on piping or thermal insulation	38
<b>Troubleshooting</b>	<b>39</b>
<b>Acceptance report / Record of inspection</b>	<b>40</b>
<b>Limited Product warranty</b>	<b>41</b>

## Overview

This manual covers the design, installation and operation of BARTEC Self-regulating trace heating systems for use in hazardous locations using the following self-regulating trace heaters:

- BARTEC PSB
- BARTEC MSB
- BARTEC HSB

The self-regulating trace heater features a temperature-dependent resistive element between two parallel copper conductors that regulates and limits the heat output of the trace heater according to the ambient temperature. If the ambient temperature rises, the power output of the trace heater is reduced. This self-regulating property prevents overheating which would cause damage to the trace heater. Even crossing or overlapping with other trace heaters (or other portions of the same trace heater) are possible.

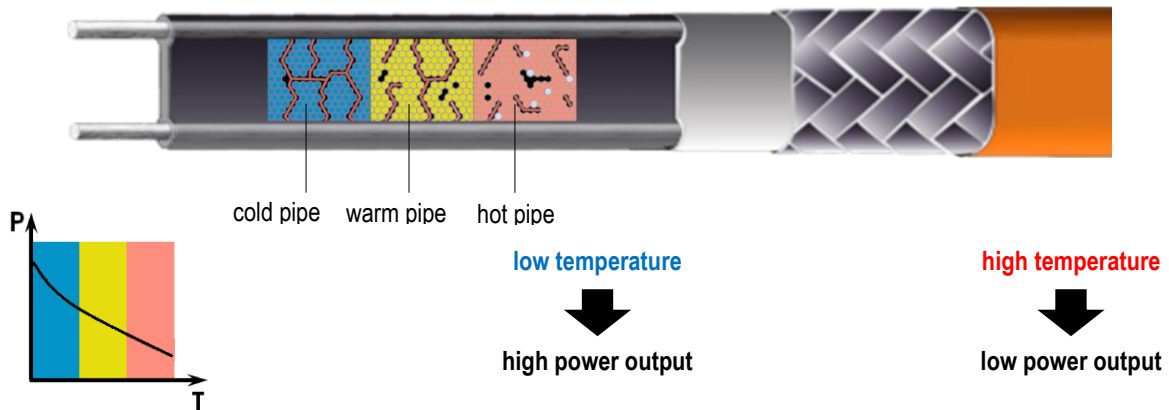

The trace heaters are fixed equipment heating systems for pipes in ordinary and hazardous areas. Thanks to the parallel design the trace heater can be cut and installed to any required length (up to the maximum heating circuit length as shown on page 15).

Multiple options for connection, splicing and end termination of the heating circuit are available to meet the individual requirements on site. A large variety of accessories allows for easy customization and extensibility. The following illustration shows a typical electric trace heating system:

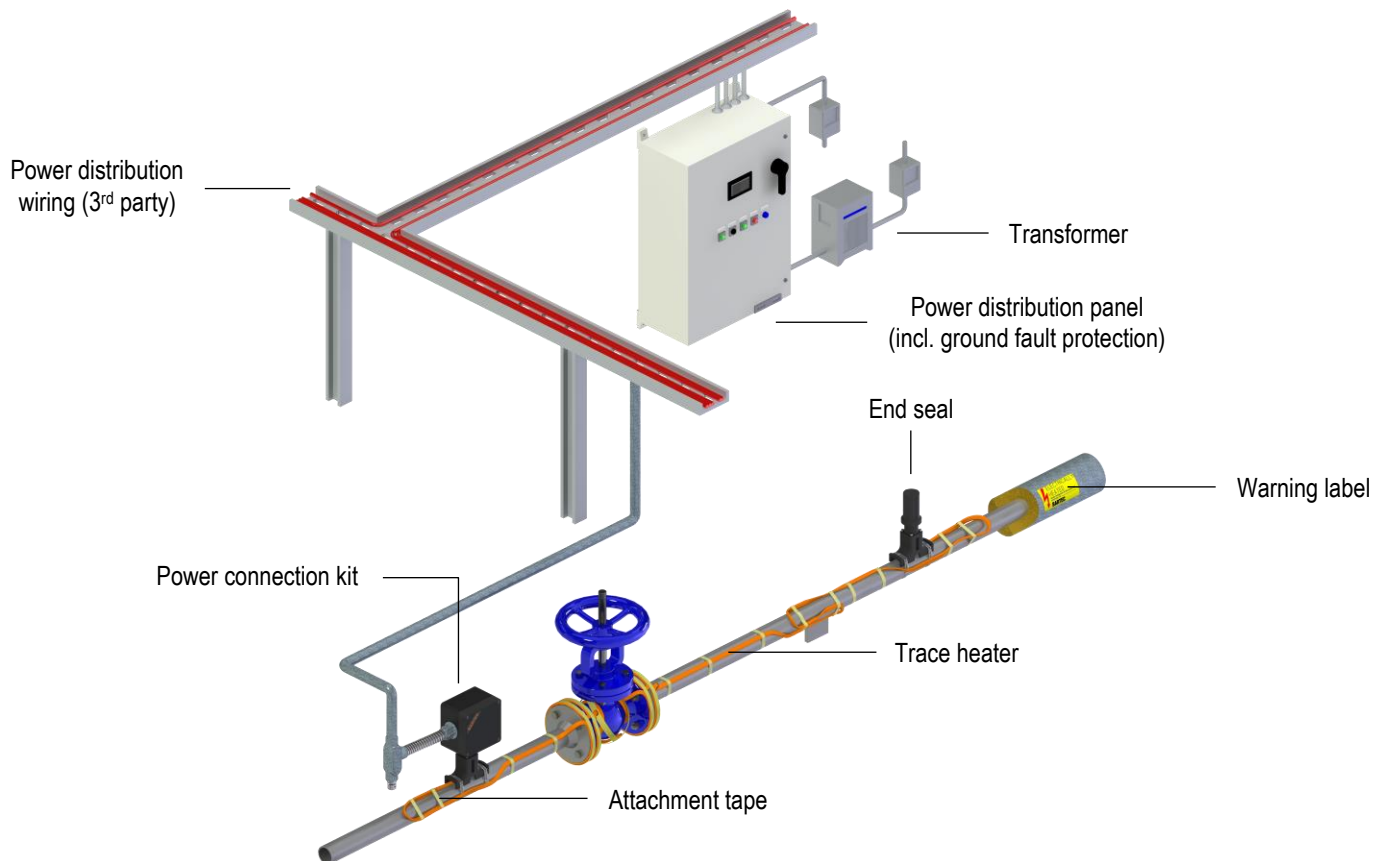

## Applications

Trace heating compensates for the heat loss through the insulation to maintain the pipe and fluid at temperatures above the freezing or solidification point. Thus, trace heating is critical for pipe freeze protection systems that are expected to have stagnant fluids for prolonged durations.

### Freeze protection:

Water, and fluids containing significant water, expand as they freeze. This expansion can cause the pipe to be blocked or break leading to:

- Economic losses: A frozen water pipe leading to a critical process like a frozen pipe in a waste water treatment plant or cooling tower can shut down the operation causing high economic losses.
- Safety issues: A frozen pipe to safety showers can jeopardize personnel safety in the event of hazardous chemical exposure.

### Temperature maintenance:

A process temperature maintenance system can maintain the temperature of the fluid in a pipe to the desired level, over a broad range of temperatures.

Maintaining liquids within the specified temperature range allows you to cost-effectively transport the fluids from one location to another, operate your processes at maximum efficiencies, and safely start/shut down your operations.

## Technical data

<b>Max. continuous operating temperature, energized</b>	<i>PSB</i>	150 °F / 65 °C
	<i>MSB</i>	233 °F / 110 °C
	<i>HSB</i>	250 °F / 120 °C
<b>Max. continuous exposure temperature, de-energized</b>	<i>PSB</i>	185 °F / 85 °C
	<i>MSB</i>	266 °F / 130 °C
	<i>HSB</i>	374 °F / 190 °C
<b>Min. operation temperature</b>	<i>PSB</i>	-67 °F / -55 °C
	<i>MSB, HSB</i>	-76 °F / -60 °C
<b>Min. installation temperature</b>	<i>PSB</i>	-40 °F / -40 °C
	<i>MSB, HSB</i>	-40 °F / -40 °C
<b>Power supply</b>	<i>PSB, MSB</i>	110 to 120 Vac / 208 to 277 Vac
	<i>HSB</i>	110 to 120 Vac / 208 to 240 Vac
<b>Trace heater output<sup>1</sup></b>	<i>PSB</i>	3 to 10 W/ft (10 to 33 W/m)
	<i>MSB, HSB</i>	5 to 20 W/ft (15 to 60 W/m)
<b>Braid resistance</b>		< 18.2 Ω/km
<b>Protection classification</b>		Class I, Div 2 Group A, B, C, D
		Class II, Div 2 Group E, F, G
		Class III
<b>Temperature classes<sup>2</sup></b>	<i>PSB</i>	T5, T6
	<i>MSB, HSB</i>	T3, T4

<sup>1</sup> nominal heat output at 50 °F (10 °C)

<sup>2</sup> according to NEC Article 500, refer to page 7 for further information

<b>Heater dimensions</b>	<i>fluoropolymer outer jacket</i>	0.45" x 0.22" (11.6 x 5.6 mm)
	<i>polyolefin outer jacket</i>	0.46" x 0.23" (11.8 x 5.8 mm)
	<i>MSB, HSB</i>	0.40" x 0.19" (10.2 x 4.8 mm)
<b>Minimum bending radius</b>		1" (25 mm)
		Do not bend on the narrow axis.

## Certifications / Approvals



Class I, Div 2 Group A, B, C, D  
Class II, Div 2 Group E, F, G  
Class III

Self-regulating trace heater for use in hazardous locations  
BARTEC PSB, BARTEC MSB, BARTEC HSB

## Safety

For safe installation and operation of BARTEC Self-regulating trace heating systems the technical requirements and instructions given in this manual must be followed.

### WARNING

**Risk of fire or electrical shock. Follow these guidelines to avoid personal injury or material damage.**

- All electrical systems and installations must comply with BARTEC GmbH requirements and be installed in accordance with the relevant electrical codes and any other applicable national and local codes.
- BARTEC GmbH, the US and Canadian electrical codes require ground fault protection to be provided for all trace heating circuits.
- Install the trace heater circuit carefully.
- Use the trace heater in accordance with the intended purpose and strictly comply with the operational data specified in section *Technical Data*.
- The bending radius of the trace heater must be at least 1" (25 mm). Do not bend on the narrow axis.
- To avoid short circuits, do not connect the trace heater bus wires together.
- Keep all components and the trace heaters dry before and during installation.
- Each heating circuit must be marked with electrical warning labels (see section *Accessories* on page 26-30).
- Keep these instructions for future reference. If applicable, leave them with the end user.
- De-energize before installation or servicing.
- Use only original BARTEC accessories.

## Personnel requirements

The personnel executing installation and maintenance tasks must have acquired the skills and specialized knowledge relating to the types of protection and types of devices concerned. At least, the personnel must have:

- a general understanding of the relevant electrical engineering
- a practical understanding of the principles and techniques of explosion protection
- a working knowledge and understanding of the relevant standards of explosion protection
- a basic knowledge of quality assurance, including the principles of auditing documentation, traceability of measurements and calibration of measurement instruments.

## System design

For the design of trace heating systems with BARTEC self-regulating trace heaters, the following steps are necessary:

- Trace heater selection
- Determination of the total required trace heater length
- Determination of the required number of trace heating circuits
- Selection of the required components and accessories for power connection, control and monitoring, end termination etc.

The following sections provide step-by-step instructions on how to proceed with each step.

## Trace heater selection

### Step 1: Familiarize yourself with the trace heater types and their properties

BARTEC self-regulating trace heaters are available in various types to suit different applications. Each trace heater is marked with a product code that contains relevant information as shown in the following example:

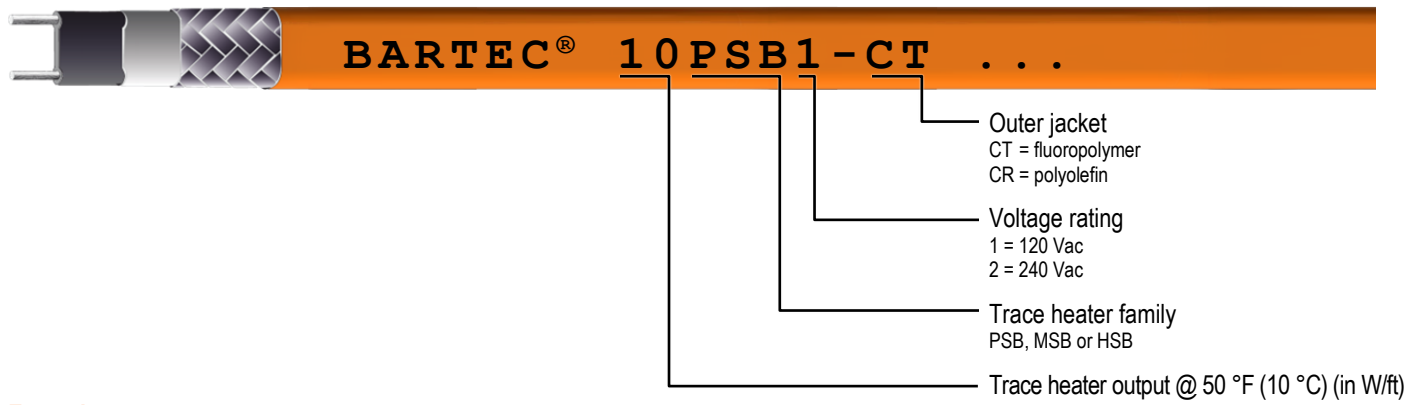

#### → Example

A trace heater that bears the marking **10PSB1-CT** has the following specifications:

- Trace heater output @ 50 °F (10 °C): **10 W/ft**
- Trace heater family: **PSB**
- Voltage rating: **120 Vac**
- Outer jacket: **fluoropolymer**

### Step 2: Determine the heat loss of your pipe setup

For proper system design it is essential to know the effective heat loss of your pipe setup. To determine it, the following data will be required:

- Pipe diameter
- Insulation thickness
- Insulation material
- Maintain temperature
- Minimum ambient temperature
- Temperature differential  $\Delta T$ :  $\Delta T = \text{maintain temperature} - \text{minimum ambient temperature}$

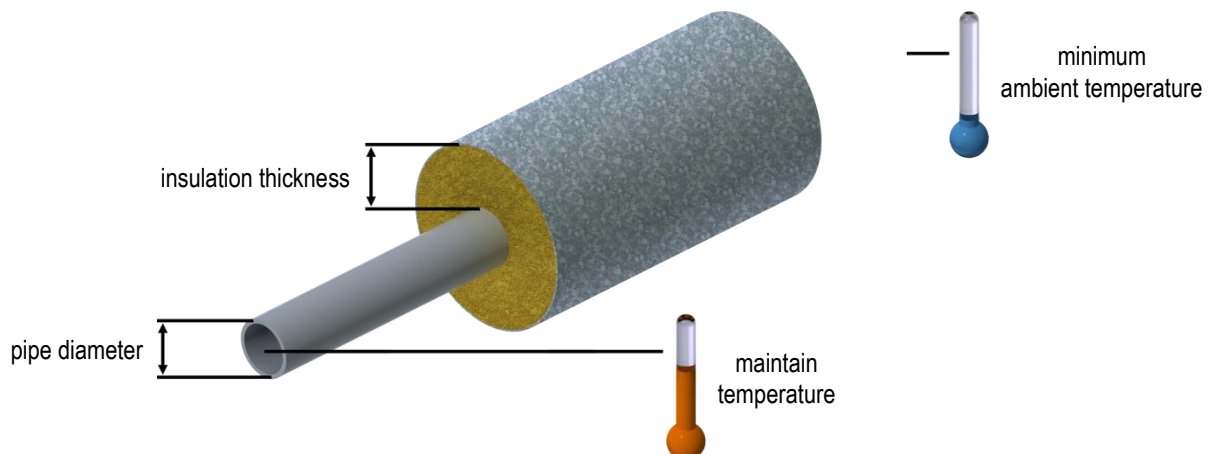

# Self-regulating trace heating systems Design Guide for Hazloc / Industrial

Next, obtain the basic heat loss in W/ft using the following TABLE A<sup>3</sup>:

		TABLE A: Basic heat loss in W/ft																				
		Pipe diameter in inch (DN) $\Delta T$ in °F (°C)	1/4" (DN8)	1/2" (DN15)	3/4" (DN20)	1" (DN25)	1 1/4" (DN32)	1 1/2" (DN40)	2" (DN50)	2 1/2" (DN65)	3" (DN80)	3 1/2" -	4" (DN100)	6" (DN150)	8" (DN200)	10" (DN250)	12" (DN300)	14" (DN350)	16" (DN400)	18" (DN450)	20" (DN500)	24" (DN600)
Insulation thickness in inch (mm)	1/2" (12.7)	50 (28)	1.9	2.5	3.0	3.5	4.2	4.7	5.6	6.8	7.8	8.8	9.8	14.0	17.9	22.1	26.0	28.5	32.4	36.4	40.3	48.2
		100 (56)	3.9	5.2	6.2	7.3	8.7	9.7	11.6	14.1	16.3	18.3	20.4	29.1	37.3	46.0	54.2	59.3	67.5	75.7	83.9	100.4
		150 (83)	6.0	8.1	9.6	11.4	13.6	15.1	18.2	22.0	25.4	28.7	31.9	45.5	58.3	71.9	84.7	92.7	105.5	118.3	131.0	156.7
		200 (111)	8.4	11.3	13.3	15.8	18.9	21.0	25.2	30.5	35.3	39.8	44.2	63.1	80.9	99.8	117.6	128.6	146.4	164.2	181.9	217.6
	1" (25.4)	50 (28)	1.3	1.6	1.9	2.1	2.5	2.7	3.2	3.8	4.4	4.8	5.3	7.5	9.4	11.5	13.5	14.7	16.7	18.7	20.6	24.6
		100 (56)	2.6	3.4	3.9	4.5	5.2	5.7	6.7	7.9	9.1	10.1	11.1	15.5	19.6	24.0	28.1	30.7	34.8	38.9	43.0	51.2
		150 (83)	4.1	5.2	6.0	7.0	8.1	8.9	10.5	12.4	14.1	15.8	17.4	24.2	30.7	37.5	43.9	47.9	54.3	60.7	67.1	79.9
		200 (111)	5.7	7.3	8.4	9.7	11.3	12.3	14.5	17.2	19.6	21.9	24.1	33.6	42.6	52.0	60.9	66.5	75.4	84.2	93.1	111.0
		250 (139)	7.4	9.5	10.9	12.6	14.7	16.1	18.9	22.4	25.6	28.5	31.4	43.8	55.4	67.7	79.3	86.5	98.1	109.6	121.2	144.4
	1 1/2" (38.1)	50 (28)	1.0	1.3	1.5	1.7	1.9	2.1	2.4	2.8	3.2	3.5	3.8	5.3	6.6	8.0	9.3	10.1	11.4	12.8	14.1	16.7
		100 (56)	2.2	2.7	3.0	3.5	4.0	4.3	5.0	5.9	6.6	7.3	8.0	11.0	13.7	16.6	19.4	21.1	23.8	26.6	29.3	34.8
		150 (83)	3.4	4.2	4.8	5.4	6.2	6.8	7.8	9.1	10.3	11.4	12.5	17.1	21.4	26.0	30.3	32.9	37.2	41.5	45.7	54.3
		200 (111)	4.7	5.8	6.6	7.5	8.6	9.4	10.9	12.7	14.3	15.9	17.4	23.8	29.7	36.1	42.0	45.7	51.6	57.6	63.5	75.4
		250 (139)	6.1	7.6	8.6	9.8	11.2	12.2	14.1	16.5	18.7	20.6	22.6	30.9	38.7	46.9	54.7	59.5	67.2	74.9	82.6	98.1
		300 (167)	7.6	9.5	10.7	12.2	14.0	15.2	17.7	20.6	23.3	25.8	28.2	38.6	48.3	58.6	68.3	74.3	84.0	93.6	103.2	122.6
	2" (50.8)	50 (28)	0.9	1.1	1.3	1.4	1.6	1.7	2.0	2.3	2.6	2.8	3.1	4.2	5.2	6.2	7.2	7.8	8.8	9.8	10.8	12.8
		100 (56)	1.9	2.3	2.6	2.9	3.3	3.6	4.1	4.8	5.4	5.9	6.4	8.7	10.7	12.9	15.0	16.3	18.3	20.4	22.5	26.6
		150 (83)	3.0	3.6	4.1	4.6	5.2	5.6	6.5	7.5	8.4	9.2	10.1	13.5	16.8	20.2	23.4	25.4	28.7	31.9	35.1	41.5
		200 (111)	4.1	5.1	5.7	6.4	7.3	7.8	9.0	10.4	11.6	12.8	14.0	18.8	23.3	28.1	32.5	35.3	39.8	44.2	48.7	57.6
		250 (139)	5.4	6.6	7.4	8.3	9.4	10.2	11.7	13.5	15.2	16.7	18.2	24.5	30.3	36.5	42.3	46.0	51.8	57.6	63.4	75.0
		300 (167)	6.7	8.2	9.2	10.4	11.8	12.7	14.6	16.9	18.9	20.8	22.7	30.6	37.9	45.6	52.9	57.4	64.7	71.9	79.1	93.7
	2.5" (63.5)	50 (28)	0.8	1.0	1.1	1.3	1.4	1.5	1.7	2.0	2.2	2.4	2.6	3.5	4.3	5.1	5.9	6.4	7.2	8.0	8.8	10.4
		100 (56)	1.7	2.1	2.3	2.6	3.0	3.2	3.6	4.1	4.6	5.0	5.5	7.3	9.0	10.7	12.4	13.4	15.1	16.7	18.3	21.6
		150 (83)	2.7	3.3	3.7	4.1	4.6	5.0	5.6	6.5	7.2	7.9	8.6	11.4	14.0	16.7	19.3	20.9	23.5	26.1	28.7	33.8
		200 (111)	3.8	4.6	5.1	5.7	6.4	6.9	7.8	9.0	10.0	10.9	11.9	15.8	19.4	23.2	26.8	29.1	32.6	36.2	39.8	46.9
		250 (139)	4.9	6.0	6.6	7.4	8.3	9.0	10.2	11.7	13.0	14.2	15.5	20.5	25.3	30.2	34.9	37.8	42.5	47.1	51.8	61.1
		300 (167)	6.2	7.4	8.3	9.2	10.4	11.2	12.7	14.6	16.3	17.8	19.3	25.7	31.6	37.8	43.6	47.3	53.1	58.9	64.7	76.3
	3" (76.2)	50 (28)	0.8	0.9	1.0	1.2	1.3	1.4	1.6	1.8	2.0	2.1	2.3	3.0	3.7	4.4	5.1	5.5	6.2	6.8	7.5	8.8
100 (56)		1.6	2.0	2.2	2.4	2.7	2.9	3.2	3.7	4.1	4.5	4.8	6.3	7.8	9.2	10.6	11.5	12.9	14.2	15.6	18.4	
150 (83)		2.5	3.0	3.4	3.7	4.2	4.5	5.1	5.8	6.4	7.0	7.5	9.9	12.1	14.4	16.6	17.9	20.1	22.2	24.4	28.7	
200 (111)		3.5	4.2	4.7	5.2	5.8	6.2	7.0	8.0	8.9	9.7	10.5	13.8	16.8	20.0	23.0	24.9	27.9	30.9	33.8	39.8	
250 (139)		4.6	5.5	6.1	6.8	7.6	8.1	9.2	10.4	11.6	12.6	13.6	17.9	21.9	26.0	30.0	32.4	36.3	40.1	44.0	51.8	
300 (167)		5.8	6.9	7.6	8.4	9.5	10.1	11.4	13.0	14.5	15.7	17.0	22.4	27.3	32.5	37.4	40.5	45.3	50.2	55.0	64.7	
4" (101.6)	50 (28)	0.7	0.8	0.9	1.0	1.1	1.2	1.3	1.5	1.7	1.8	1.9	2.5	3.0	3.5	4.0	4.4	4.8	5.3	5.8	6.8	
	100 (56)	1.5	1.7	1.9	2.1	2.3	2.5	2.8	3.1	3.4	3.7	4.0	5.2	6.2	7.4	8.4	9.1	10.1	11.1	12.2	14.2	
	150 (83)	2.3	2.7	3.0	3.3	3.6	3.9	4.3	4.9	5.4	5.8	6.3	8.1	9.7	11.5	13.1	14.1	15.8	17.4	19.0	22.2	
	200 (111)	3.2	3.8	4.1	4.6	5.1	5.4	6.0	6.8	7.5	8.1	8.7	11.2	13.5	16.0	18.2	19.6	21.9	24.1	26.4	30.9	
	250 (139)	4.2	4.9	5.4	5.9	6.6	7.0	7.8	8.8	9.7	10.5	11.3	14.6	17.6	20.8	23.7	25.6	28.5	31.4	34.3	40.2	
	300 (167)	5.2	6.1	6.7	7.4	8.2	8.7	9.8	11.0	12.1	13.1	14.1	18.2	22.0	25.9	29.6	31.9	35.6	39.2	42.9	50.2	
350 (194)	6.3	7.4	8.2	9.0	10.0	10.6	11.9	13.4	14.7	16.0	17.2	22.1	26.7	31.5	36.0	38.8	43.2	47.7	52.1	61.0		

<sup>3</sup> Heat loss calculations are based on IEC/IEEE 60079-30-1:2015 Annex C and IEC/IEEE 60079-30-2:2015 Annex E. The following assumptions have been made:

- Medium not in motion
- Single layer insulation
- No gap between pipe and insulation layer
- No gap between insulation layer and weather shielding
- Outdoor installation, wind speed: 20 m/s
- Application of a safety factor of +10 %



Finally, you must apply the following correction factors depending on your insulation material:

		TABLE B: Insulation Correction Factors	
		Correction Factor	thermal conductivity at 68 °F (20 °C) in BTU/hr - °F - ft <sup>2</sup> /in(W/m·K)
Insulation material	Fiberglass (ASTM C547 Type II)	1.00*	0.26 (0.037)
	Mineral wool (ASTM C1393)	1.05*	0.27 (0.039)
	Calcium silicate (ASTM C533 Type I)	1.48*	0.36 (0.052)
	Cellular glass (ASTM C552 Grade 2)	1.56*	0.38 (0.055)
	Rigid cellular urethane (ASTM C591 Type I)	0.82*	0.22 (0.032)
	Foamed elastomer (ASTM C534)	1.22*	0.31 (0.045)
	Expanded perlite (ASTM C610)	1.90*	0.48 (0.069)

\*applies for -13 to 158°F (-25 to 70°C), for further information contact your local BARTEC distributor

→ **Example**

- Pipe diameter: 1 1/4"
  - Insulation thickness: 1"
  - Insulation material: **calcium silicate**
  - Minimum ambient temperature: -20 °F
  - Maintain temperature: 80 °F
- }  $\Delta T = 80\text{ °F} - (-20\text{ °F}) = 100\text{ °F}$

We obtain the basic heat loss in W/ft from TABLE A on page 6:

		Basic heat loss in W/ft										
		Pipe diameter in inch (DN)	1/4" (DN8)	1/2" (DN15)	3/4" (DN20)	1" (DN25)	1 1/4" (DN32)	1 1/2" (DN40)	2" (DN50)	2 1/2" (DN65)	3" (DN75)	
		$\Delta T$ in °F (°C)										
Insulation thickness in inch (mm)	1/2" (12.7)	50 (28)	1.9	2.5	3.0	3.5	4.2	4.7	5.6	6.8	7.8	
		100 (56)	3.9	5.2	6.2	7.3	8.7	9.7	11.6	14.1	16.1	
		150 (83)	6.0	8.1	9.6	11.4	13.6	15.1	18.2	22.0	25.5	
	1 (25.4)	200 (111)	8.4	11.3	13.3	15.8	18.9	21.0	25.2	30.5	35.8	
		50 (28)	1.3	1.6	1.9	2.1	2.5	2.7	3.2	3.8	4.5	
		100 (56)	2.6	3.4	3.9	4.5	5.2	5.7	6.7	7.9	9.3	
1 1/2" (38.1)	150 (83)	4.1	5.2	6.0	7.0	8.1	8.9	10.5	12.6	14.7		
	200 (111)	5.7	7.3	8.4	9.7	11.3	12.3	14.5	17.4	20.3		
	250 (139)	7.4	9.5	10.9	12.6	14.7	16.1	18.9	22.8	26.7		
2" (50.8)	50 (28)	1.0	1.3	1.5	1.7	1.9	2.1	2.4	2.8	3.3		
	100 (56)	2.0	2.7	3.0	3.5	4.0	4.3	5.0	5.9	6.9		
	150 (83)	3.0	4.0	4.5	5.2	6.0	6.2	7.4	8.8	10.4		

basic heat loss: 5.2 W/ft

Now, the correction factors from TABLE B on page 7 must be checked and if necessary, applied:

		Correction Factor
Insulation material	Fiberglass (ASTM C547 Type II)	1.00*
	Mineral wool (ASTM C335-89)	0.95*
	Calcium silicate (ASTM C533 Type I)	1.48*
	Cellular glass (ASTM C552 Grade 2)	1.56*
	Rigid cellular urethane (ASTM C591 Type I)	0.82*
Foamed elastomer (ASTM C534)		1.22*

correction factor insulation: 1.48

The effective heat loss of the setup is determined as follows:

effective heat loss = basic heat loss × correction factor insulation  
 = 5.2 W/ft × 1.48  
 = 7.7 W/ft

**Step 3: Choose a trace heater family**

Determine the requirements for your trace heating application:

- Maximum exposure temperature (continuous / intermittent)
- Minimum operation / start-up temperature (continuous / intermittent)
- Required heat output to compensate for the effective heat loss as calculated in Step 2
- Required temperature class (“T-Rating”)

Pick the trace heater family that meets your requirements using the following TABLE C Heater Family Selection:

		TABLE C: Heater Family Selection		
Max. continuous operating temperature, energized	<i>PSB</i>	150 °F / 65 °C		
	<i>MSB</i>	233 °F / 110 °C		
	<i>HSB</i>	250 °F / 120 °C		
Max. continuous exposure temperature, de-energized	<i>PSB</i>	185 °F / 85 °C		
	<i>MSB</i>	266 °F / 130 °C		
	<i>HSB</i>	374 °F / 190 °C		
Min. operation temperature	<i>PSB</i>	-67 °F / -55 °C		
	<i>MSB, HSB</i>	-76 °F / -60 °C		
Min. installation temperature	<i>PSB, MSB, HSB</i>	-40 °F / -40 °C		
Trace heater output <sup>4</sup>	<i>PSB</i>	3 to 10 W/ft (10 to 33 W/m)		
	<i>MSB, HSB</i>	5 to 20 W/ft (15 to 60 W/m)		
Temperature classes <sup>5</sup>	<i>PSB</i>	<b>Rated voltage</b>	<b>Power output</b>	<b>Temperature class</b>
		208 to 277 Vac	3, 5 W/ft	T6
		110 to 120 Vac	8, 10 W/ft	T5
	<i>MSB</i>	<b>Rated voltage</b>	<b>Power output</b>	<b>Temperature class</b>
		208 to 277 Vac	5 W/ft	T4
		110 to 120 Vac	10, 15, 20 W/ft	T3
	<i>HSB</i>	<b>Rated voltage</b>	<b>Power output</b>	<b>Temperature class</b>
		208 to 240 Vac	5 W/ft	T4
		110 to 120 Vac	10, 15, 20 W/ft	T3

**NOTICE**

If you want to use plastic piping within your installation, contact your local BARTEC distributor for verification that the design does not exceed the maximum withstand temperature of the pipe material. Also, adjustments in heat loss calculations may be required.

→ **Example**

- Maximum exposure temperature: **80 °F (continuous), 100 °F (intermittent)**
- Minimum operation temperature: **-20 °F**
- Required heat output: **7.7 W/ft**
- Required temperature class: **T5**

Trace heater family that meets the requirements: **PSB**

<sup>4</sup> nominal heat output at 50 °F (10 °C)

<sup>5</sup> temperature classes according to NEC Article 500 (max. surface temperature):

- T6 : 185 °F (85 °C)
- T5 : 212 °F (100 °C)
- T4 : 275 °F (135 °C)
- T3 : 392 °F (200 °C)

## Step 4: Determine the required power rating

Since the power output of self-regulating trace heaters depends on the pipe temperature, the conditions within your application must be considered when choosing the trace heater:

- Determine the maintain temperature (= pipe temperature) of your application and the effective heat loss as calculated in Step 2.
- Find the required power output in the graph that contains the trace heater type and voltage you use (see graphs on pages 10 to 12).
- If the required power output is between 2 trace heater types, choose the one with the higher rating.
- If the required power output exceeds the output of the trace heater with the highest rating, you may:
  - Use 2 or more trace heaters on the same pipe.
  - Use a thicker insulation or insulation material with a lower thermal conductivity.
  - Contact your local BARTEC distributor for further assistance.

### → Example

- Maintain temperature: **80 °F**
- Effective heat loss: **7.7 W/ft**
- Trace heater family as determined in Step 3: **PSB**
- Power supply voltage: **240 Vac**

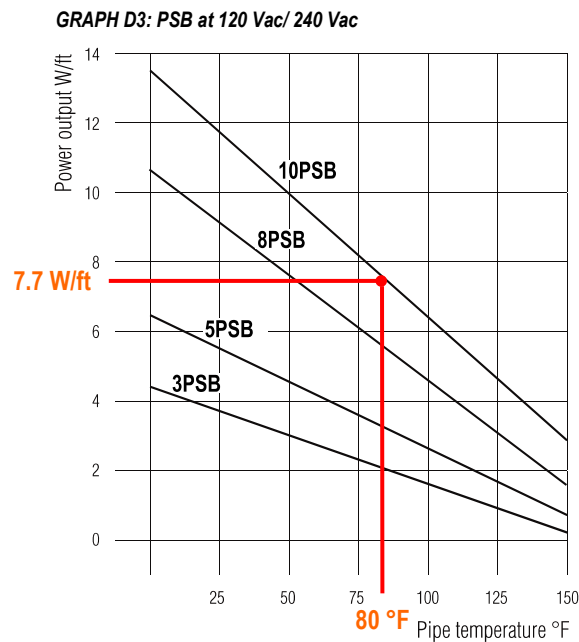

Trace heater that meets the required power output: **10 PSB**

Catalog No. for the selected trace heater: **10PSB2-xx**

**GRAPH D1: PSB at 120 Vac / 240 Vac**

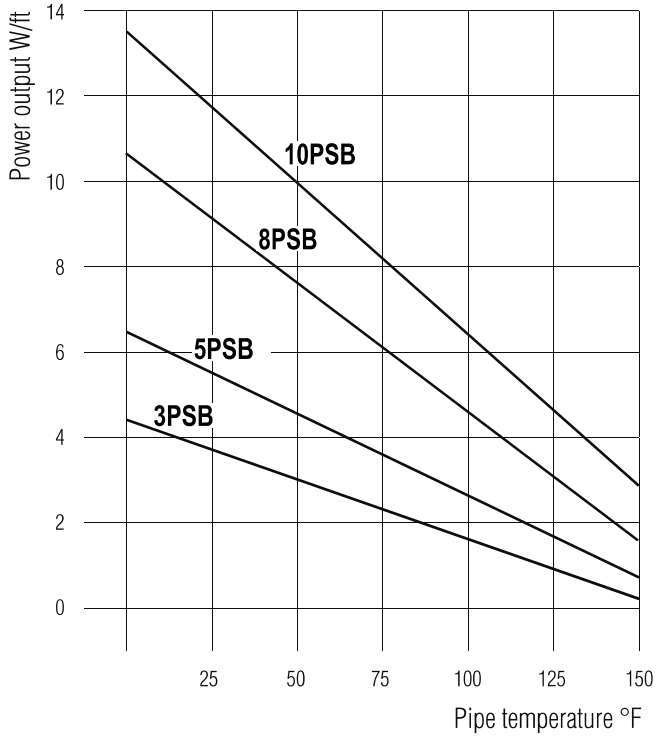

For MSB trace heaters see page 11.
For HSB trace heaters see page 12.

**GRAPH F1: MSB at 120 Vac / 240 Vac**

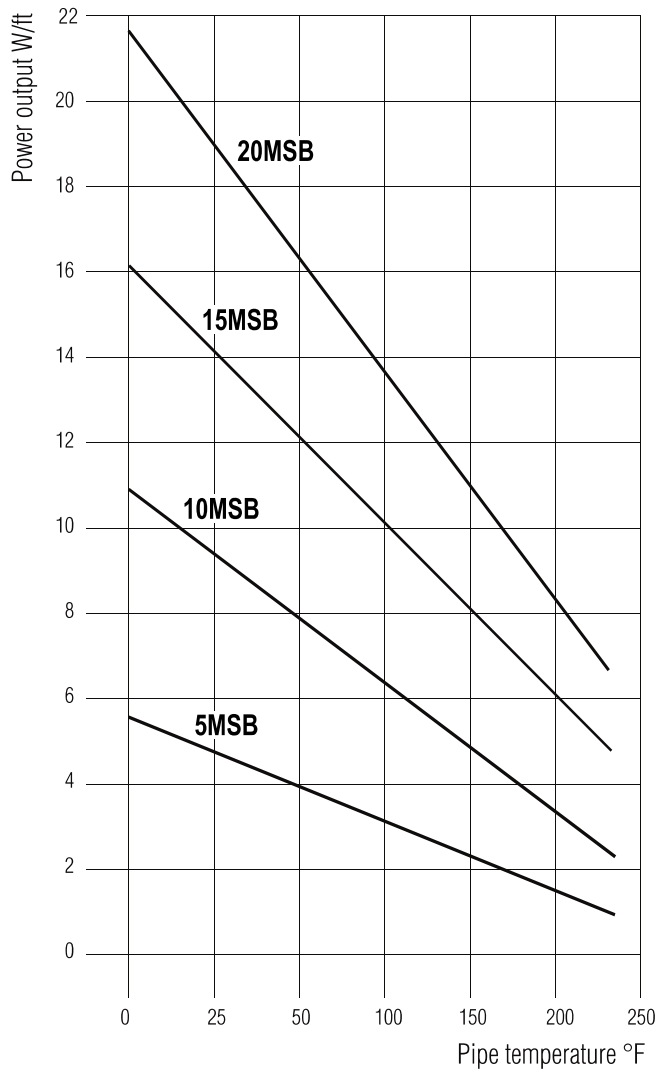

For PSB trace heaters see page 10.
For HSB trace heaters see page 12.

**GRAPH F1: HSB at 120 Vac / 240 Vac**

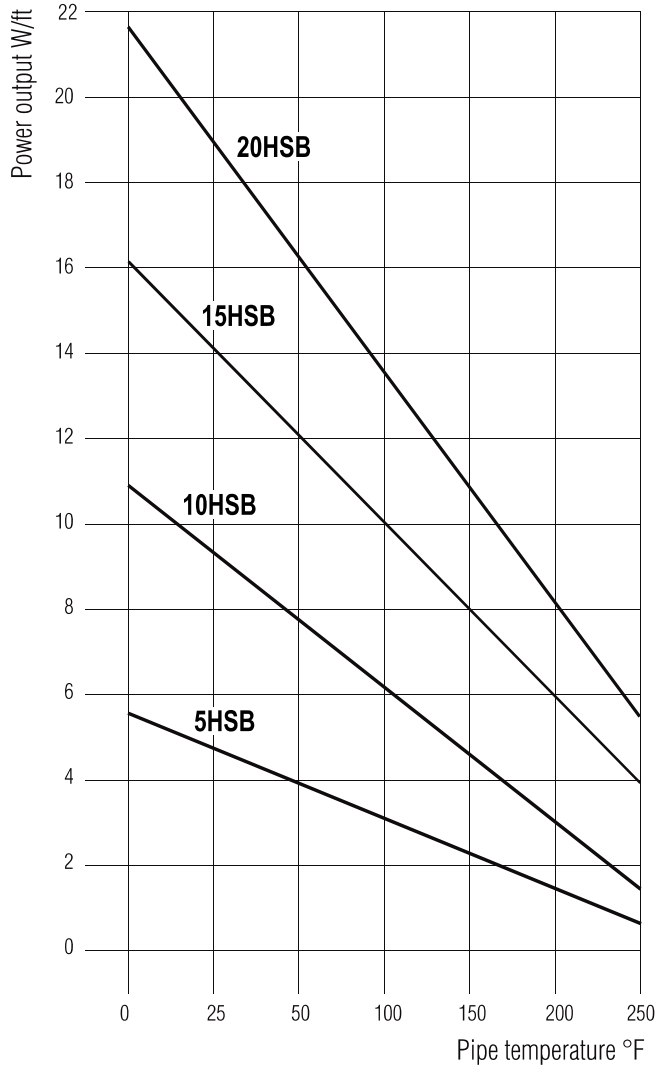

For PSB trace heaters see page 10.
For MSB trace heaters see page 11.

## Step 5: Select the appropriate outer jacket material

BARTEC self-regulating trace heaters are available with 2 different types of outer jackets. Choose the outer jacket that suits the chemical environment it will be exposed to. For questions regarding the chemical resistance please contact your local BARTEC distributor.

TABLE G: Outer Jacket Chemical Resistance			
	Application	Catalog No.	Heater Family
Fluoropolymer outer jacket	exposure to organic chemicals	...-CT	PSB, MSB or HSB
Polyolefin outer jacket	exposure to aqueous, inorganic chemicals	...-CR	PSB only

### → Example

- Trace heating systems for process applications in the oil industry: **fluoropolymer outer jacket**
- Trace heater Catalog No. that meets the required power output and environmental conditions: **10PSB2-CT**

## Determination of the required trace heater length

The total required trace heater length is determined by taking into account the trace heater length for piping as well as allowances for valves, pumps, flanges, pipe supports and connection kits.

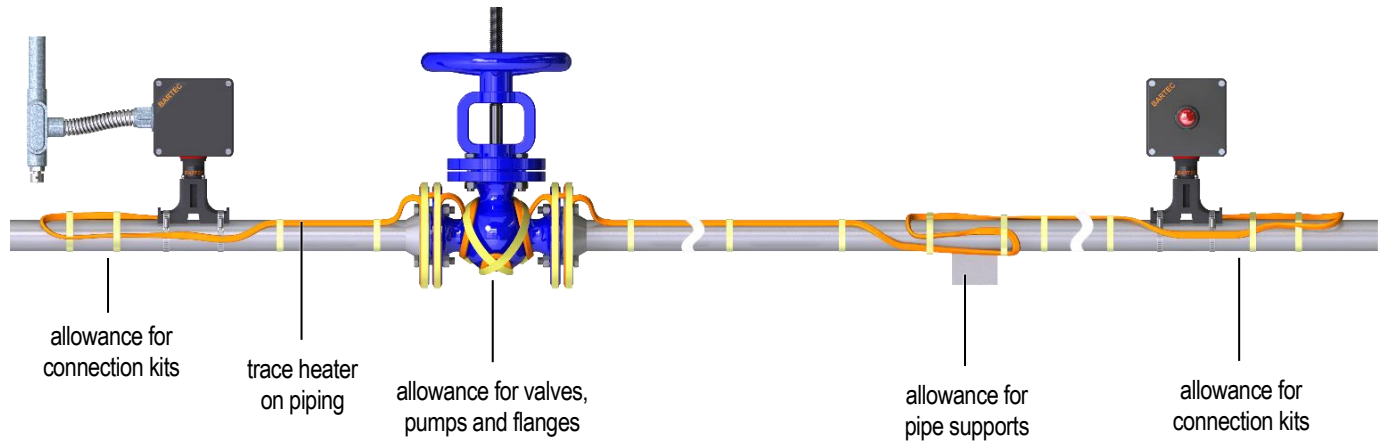

## Step 6: Determine the required trace heater length for the piping:

The required trace heater length for piping corresponds to the pipe length.

### → Example

100 ft. of piping = **100 ft. of 10PSB2-CT trace heater**

## Step 7: Determine the required allowance for connection kits:

The required allowance for connection kits is 1.6 ft (0.5 m) for each kit.

### → Example

- Heating circuit with 1 power connection kit and 1 end of line lamp

The total required allowance is calculated as follows:

$$\begin{aligned}
 \text{total required allowance} &= \text{no. of connection kits} \times 1.6 \text{ ft} \\
 &= 2 \times 1.6 \text{ ft} \\
 &= \underline{\underline{3.2 \text{ ft}}}
 \end{aligned}$$

**Step 8: Determine the required allowance for pumps, valves, flanges and pipe supports:**

Determine the required allowances for pumps, valves, flanges and pipe supports using the following TABLE H Allowance Factors:

TABLE H: Heat Loss Allowance Factors																			
Pipe diameter in inch (DN)	1/4" (DN8)	1/2" (DN15)	3/4" (DN20)	1" (DN25)	1 1/4" (DN32)	1 1/2" (DN40)	2" (DN50)	2 1/2" (DN65)	3" (DN80)	4" (DN100)	6" (DN150)	8" (DN200)	10" (DN250)	12" (DN300)	14" (DN350)	16" (DN400)	18" (DN450)	20" (DN500)	24" (DN600)
Allowance for pumps in ft (m)	4.9 (1.5)	6.6 (2.0)	6.6 (2.0)	6.9 (2.1)	7.5 (2.3)	7.5 (2.3)	7.9 (2.4)	7.9 (2.4)	7.9 (2.4)	8.5 (2.6)	9.8 (3.0)	11.5 (3.5)	13.1 (4.0)	13.1 (4.0)	13.1 (4.0)	13.8 (4.2)	14.8 (4.5)	16.4 (5.0)	23 (7.0)
Allowance for valves in ft (m)	1.6 (0.5)	1.6 (0.5)	1.6 (0.5)	2.0 (0.6)	2.0 (0.6)	2.3 (0.7)	2.3 (0.7)	3.3 (1.0)	3.3 (1.0)	4.3 (1.3)	4.9 (1.5)	5.2 (1.6)	5.9 (1.8)	6.6 (2.0)	6.6 (2.0)	7.2 (2.2)	8.2 (2.5)	8.9 (2.7)	9.5 (2.9)
Allowance for flanges in ft (m)	0.7 (0.2)	0.7 (0.2)	1.0 (0.3)	1.0 (0.3)	1.0 (0.3)	1.0 (0.3)	1.3 (0.4)	1.3 (0.4)	1.6 (0.5)	2.3 (0.7)	3.0 (0.9)	3.3 (1.0)	3.9 (1.2)	3.9 (1.2)	3.9 (1.2)	4.3 (1.3)	4.3 (1.3)	4.6 (1.4)	5.9 (1.8)
Allowance for pipe supports in ft (m)	0.7 (0.2)	0.7 (0.2)	1.0 (0.3)	1.0 (0.3)	1.0 (0.3)	1.0 (0.3)	1.3 (0.4)	1.3 (0.4)	1.6 (0.5)	2.3 (0.7)	3.0 (0.9)	3.3 (1.0)	3.9 (1.2)	3.9 (1.2)	3.9 (1.2)	4.3 (1.3)	4.3 (1.3)	4.6 (1.4)	5.9 (1.8)

→ **Example**

- Pipe diameter: 1 1/4"
- 1 pump
- 2 valves
- 6 flanges
- 4 pipe supports

The total required allowance is calculated as follows:

$$\begin{aligned}
 \text{total required allowance} &= \text{no. of pumps} \times \text{pump allowance value} + \\
 &\quad \text{no. of valves} \times \text{valve allowance value} + \\
 &\quad \text{no. of flanges} \times \text{flange allowance value} + \\
 &\quad \text{no. of pipe supports} \times \text{pipe support allowance value} \\
 &= 1 \times 7.5 \text{ ft} + 2 \times 2.0 \text{ ft} + 6 \times 1.0 \text{ ft} + 4 \times 1.0 \text{ ft} \\
 &= \underline{21.5 \text{ ft}}
 \end{aligned}$$

**Step 9: Add all lengths / allowances together:**

Add the lengths for piping (as determined in Step 6) and allowances (as determined in Step 7 and Step 8) together to obtain total required trace heater length.

→ **Example**

- required trace heater length for piping (Step 6): **100 ft**
- required allowances for connection kits (Step 7): **3.2 ft**
- required allowances for pumps, valves, flanges and pipe supports (Step 8): **21.5 ft**

$$\begin{aligned}
 \text{total required trace heater length} &= \text{required trace heater length for piping} + \text{required allowances} \\
 &= 100 \text{ ft} + 3.2 \text{ ft} + 21.5 \text{ ft} \\
 &= \underline{124.7 \text{ ft}}
 \end{aligned}$$

**Determination of the required number of heating circuits**

**Step 10: Confirm the number of electrical circuits required for the application:**

Using TABLE I on page 15 compare the required heater length and start up temperature to the available circuit breaker allowances to determine the number of electrical circuits that will be required.

→ **Example**

- required trace heater length for piping: **124.7 ft**
- required start-up temperature: **-20 °F**
- available circuit breaker voltage: **240 Vac**
- available circuit breaker amperage: **20 A**

Trace heater type	Start-up temperature °F (°C)	TABLE I: Maximum heating circuit length		
		Operating Voltage: 240 Vac		
		20 A	30 A	40 A
10 PSB 07-5801-.33.	+50 (+10)	295 (90)	335 (102)	361 (110)
	0 (-18)	197 (60)	276 (84)	295 (90)
	-20 (-29)	<b>171 (52)</b>	236 (72)	262 (80)
	-40 (-40)	131 (40)	197 (60)	230 (70)
	-60 (-41)	620 (189)	620 (189)	620 (189)

$$\begin{aligned}
 \text{allowable trace heater length from table below} &= \text{maximum of } 171 \text{ ft at } -20 \text{ F on } 20 \text{ A circuit breaker at } 240 \text{ Vac} \\
 &= 124.7 \text{ ft calculated} < 171 \text{ ft maximum allowable for } 20 \text{ A} \\
 &= \underline{1 \text{ circuit}}
 \end{aligned}$$



TABLE I shows the maximum circuit length for one continuous length of cable, not the sum of segments of cable. If feeding multiple cable segments from the single circuit breaker, please refer to BARTEC HELOC design software or contact BARTEC technical support. Breaker sizing should be based on the National Electrical Code, Canadian Electrical Code or any other local or applicable code. Use only circuit breakers with type C tripping characteristics.

## WARNING

**Risk of fire, electrical shock or dysfunction. Observe the maximum amperage of all components of the trace heating circuit. If the required trace heater length exceeds the maximum heating circuit length you must install multiple heating circuits.**

Trace heater type		Start-up temperature °F (°C)	TABLE I: Maximum heating circuit length in ft. (m)					
			Operating Voltage: 120 Vac			Operating Voltage: 240 Vac		
			20 A	30 A	40 A	20 A	30 A	40 A
PSB	3PSB 07-5853-.10.	+50 (+10)	344 (105)	344 (105)	344 (105)	676 (206)	676 (206)	676 (206)
		0 (-18)	285 (87)	344 (105)	344 (105)	545 (166)	676 (206)	676 (206)
		-20 (-29)	256 (78)	344 (105)	344 (105)	492 (150)	676 (206)	676 (206)
		-40 (-40)	233 (71)	344 (105)	344 (105)	446 (136)	669 (204)	676 (206)
	5PSB 07-5853-.15.	+50 (+10)	279 (85)	282 (86)	282 (86)	538 (164)	558 (170)	558 (170)
		0 (-18)	200 (61)	282 (86)	282 (86)	387 (118)	558 (170)	558 (170)
		-20 (-29)	180 (55)	272 (83)	282 (86)	348 (106)	522 (159)	558 (170)
		-40 (-40)	164 (50)	246 (75)	282 (86)	315 (96)	476 (145)	558 (170)
	8PSB 07-5853-.26.	+50 (+10)	190 (58)	217 (66)	217 (66)	315 (96)	433 (132)	433 (132)
		0 (-18)	141 (43)	213 (65)	217 (66)	233 (71)	351 (107)	433 (132)
		-20 (-29)	128 (39)	194 (59)	217 (66)	213 (65)	318 (97)	423 (129)
		-40 (-40)	118 (36)	177 (54)	217 (66)	194 (59)	292 (89)	387 (118)
	10PSB 07-5853-.33.	+50 (+10)	154 (47)	164 (50)	164 (50)	200 (61)	299 (91)	328 (100)
		0 (-18)	115 (35)	164 (50)	164 (50)	148 (45)	223 (68)	295 (90)
		-20 (-29)	105 (32)	154 (47)	164 (50)	135 (41)	200 (61)	269 (82)
		-40 (-40)	95 (29)	141 (43)	164 (50)	121 (37)	184 (56)	246 (75)
MSB	5MSB 07-5854-.15.	+50 (+10)	279 (85)	322 (98)	322 (98)	538 (164)	627 (191)	627 (191)
		0 (-18)	243 (74)	322 (98)	322 (98)	469 (143)	627 (191)	627 (191)
		-20 (-29)	233 (71)	322 (98)	322 (98)	446 (136)	627 (191)	627 (191)
		-40 (-40)	223 (68)	322 (98)	322 (98)	427 (130)	627 (191)	627 (191)
	10MSB 07-5854-.30.	+50 (+10)	157 (48)	226 (69)	226 (69)	302 (92)	443 (135)	443 (135)
		0 (-18)	135 (41)	203 (62)	226 (69)	259 (79)	390 (119)	443 (135)
		-20 (-29)	128 (39)	194 (59)	226 (69)	246 (75)	371 (113)	443 (135)
		-40 (-40)	121 (37)	184 (56)	226 (69)	236 (72)	354 (108)	443 (135)
	15MSB 07-5854-.45.	+50 (+10)	115 (35)	138 (42)	138 (42)	220 (67)	276 (84)	276 (84)
		0 (-18)	98 (30)	138 (42)	138 (42)	190 (58)	276 (84)	276 (84)
		-20 (-29)	95 (29)	138 (42)	138 (42)	180 (55)	272 (83)	276 (84)
		-40 (-40)	92 (28)	135 (41)	138 (42)	174 (53)	259 (79)	276 (84)
	20MSB 07-5854-.60.	+50 (+10)	89 (27)	128 (39)	128 (39)	171 (52)	253 (77)	253 (77)
		0 (-18)	79 (24)	118 (36)	128 (39)	148 (45)	223 (68)	253 (77)
		-20 (-29)	75 (23)	112 (34)	128 (39)	141 (43)	210 (64)	253 (77)
		-40 (-40)	72 (22)	105 (32)	128 (39)	135 (41)	200 (61)	253 (77)

<b>HSB</b>	5HSB 07-5803-.15.	+50 (+10)	279 (85)	322 (98)	322 (98)	538 (164)	627 (191)	627 (191)
		0 (-18)	243 (74)	322 (98)	322 (98)	469 (143)	627 (191)	627 (191)
		-20 (-29)	233 (71)	322 (98)	322 (98)	446 (136)	627 (191)	627 (191)
		-40 (-40)	223 (68)	322 (98)	322 (98)	427 (130)	627 (191)	627 (191)
	10HSB 07-5803-.30.	+50 (+10)	157 (48)	226 (69)	226 (69)	302 (92)	443 (135)	443 (135)
		0 (-18)	135 (41)	203 (62)	226 (69)	259 (79)	390 (119)	443 (135)
		-20 (-29)	128 (39)	194 (59)	226 (69)	246 (75)	371 (113)	443 (135)
		-40 (-40)	121 (37)	184 (56)	226 (69)	236 (72)	354 (108)	443 (135)
	15HSB 07-5803-.45.	+50 (+10)	115 (35)	138 (42)	138 (42)	220 (67)	276 (84)	276 (84)
		0 (-18)	98 (30)	138 (42)	138 (42)	190 (58)	276 (84)	276 (84)
		-20 (-29)	95 (29)	138 (42)	138 (42)	180 (55)	272 (83)	276 (84)
		-40 (-40)	92 (28)	135 (41)	138 (42)	174 (53)	259 (79)	276 (84)
	20HSB 07-5803-.60.	+50 (+10)	89 (27)	128 (39)	128 (39)	171 (52)	253 (77)	253 (77)
		0 (-18)	79 (24)	118 (36)	128 (39)	148 (45)	223 (68)	253 (77)
		-20 (-29)	75 (23)	112 (34)	128 (39)	141 (43)	210 (64)	253 (77)
		-40 (-40)	72 (22)	105 (32)	128 (39)	135 (41)	200 (61)	253 (77)

**Selection of the required components for power connection, control and monitoring, end termination etc.**

A typical heating circuit with self-regulating trace heaters consists of:

- Power supply / cold lead cable connection
- Trace heater splices / junctions (optional)
- Control and monitoring units (optional)
- End termination

**Step 11: Determine the required trace heater power connection kit:**

→ **Example**

- From Step 10,1 Heating circuit with 1 power connection kit = **PBS-200-A**.

**Step 12: Determine if control equipment is required:**

BARTEC provides a variety of control products, from simple mechanical thermostats to sophisticated digital controllers and control and monitoring systems designed specifically for use with our trace heating products. This section will help you select and specify the right control products for your application.

**General design considerations for temperature control:**

When designing your trace heating system, you should consider the following factors.

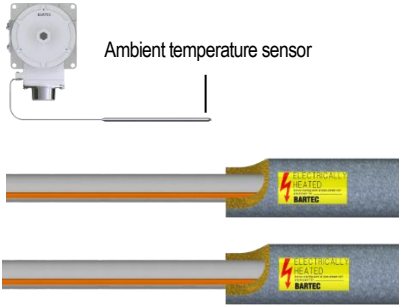
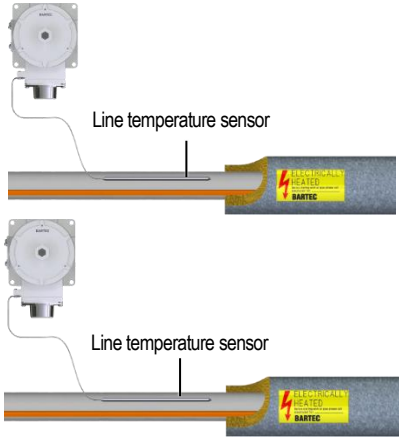

- Adding control elements increases the installation and maintenance costs of the heating system, but allows tighter temperature control, energy savings and more efficient use of plant maintenance personnel's time.
- The thermal environment of a trace heating system varies greatly, especially at valves, pipe supports, and other heat sinks. It is therefore seldom possible to achieve very tight temperature control.
- The temperature of a heat tracing system is based on ambient temperature and can vary by as much as 68 °F / 20 °C when the system is uncontrolled. You can choose between 2 approaches for temperature control:

<p><b>Ambient sensing control</b></p>	 <p>Ambient temperature sensor</p>	<p>Ambient sensing control:</p> <ul style="list-style-type: none"> <li>▪ uses an on-off thermostat that senses ambient temperature</li> <li>▪ is more energy efficient than self-regulating control because the heating circuit is energized only when the temperature drops below the set-point</li> <li>▪ is most suitable for freeze-protection applications where multiple circuits can be controlled by a single sensing point</li> <li>▪ flow path considerations (flowing or non-flowing) are not required with ambient control.</li> </ul>
<p><b>Line sensing control</b></p>	 <p>Line temperature sensor</p> <p>Line temperature sensor</p>	<p>Line sensing control:</p> <ul style="list-style-type: none"> <li>▪ regulates the desired maintain temperature by turning the heating circuit on if the pipe temperature falls below the set-point and turning it off if it exceeds the set-point</li> <li>▪ the most energy-efficient method for controlling heat tracing is a line-sensing thermostat, because a flowing pipe will typically not need any additional heat to keep it at the proper temperature</li> <li>▪ needs a separate circuit controlled by a line-sensing thermostat for each flow path</li> <li>▪ where a piping system has tees and therefore multiple flow paths, more than one thermostat may be required.</li> </ul>

## NOTICE

Line sensing provides tighter temperature control than ambient sensing but flow paths may require additional controllers.

### Overview of control equipment:

<p><b>Mechanical thermostats</b></p>		<p><b>BMC-1A</b></p> <ul style="list-style-type: none"> <li>▪ Fixed set point at 40 °F (5 °C) set point</li> <li>▪ NEMA Type 4x enclosure in coated cast aluminium with stainless steel hardware</li> <li>▪ SPDT switch rated 480 Vac, 22 A</li> <li>▪ UL Listed and CSA certified for use in non-hazardous locations</li> </ul>
		<p><b>DTW-1A</b></p> <ul style="list-style-type: none"> <li>▪ Fixed set point mechanical thermostat with a 40 °F (5 °C) set point</li> <li>▪ NEMA Type 4,7,9 in coated cast aluminium enclosure</li> <li>▪ SPDT switch rated 480 Vac, 22 A</li> <li>▪ UL Listed and CSA certified for use in Division 1 and 2 hazardous locations</li> </ul>

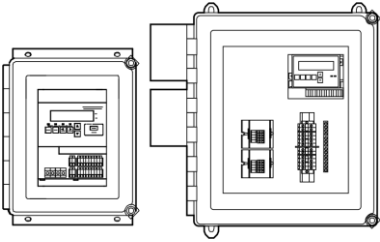
		<p><b>DTW-1L</b></p> <ul style="list-style-type: none"> <li>Adjustable set point between 25 °F and 325 °F (-4 °C and 163 °C)</li> <li>NEMA Type 4,7,9 in coated cast aluminium enclosure</li> <li>SPDT switch rated 480 Vac, 22 A</li> <li>UL Listed and CSA certified for use in Division 1 and 2 hazardous locations</li> </ul>
<p>Electronic controllers</p>		<p><b>BARTEC TraceMate and BARTEC TraceMate II</b></p> <ul style="list-style-type: none"> <li>TraceMate is a single point controller</li> <li>TraceMate II is a dual-point controller</li> <li>Continuous monitoring technology for                         <ul style="list-style-type: none"> <li>heat-tracing faults</li> <li>monitoring of the heat tracing current</li> </ul> </li> <li>Integral ground fault protection</li> <li>Networking capabilities</li> <li>TraceMate and TraceMate II are CSA certified for use in non-hazardous and Zone 2 locations</li> </ul>

**Table J: Recommendations for selecting the appropriate control equipment:**

Base your selection on the number and type of trace heating circuits to be installed, the type of control you need, and the area classification.

TABLE J: Control Equipment Selection Recommendations				
Heating circuit type	Application	Control options	Suitable BARTEC control product	Quantity required
Self-regulating heating circuits on pipes	Freeze protection	Ambient-sensing	BMC-1A (ordinary locations) DTW-1A (hazardous locations)	1 per control panel
Self-regulating heating circuits on pipes	Temperature maintenance or tight temperature control	Line-sensing	DTW-1L (hazardous locations)	1 per circuit
Group heating circuit(s) on tanks	Freeze Protection or wide band temperature control	Ambient-sensing	BMC-1A (ordinary locations) DTW-1A (hazardous locations)	1 per control panel
Any heating circuit(s) on tanks	Temperature maintenance or tight temperature control	Point-sensing	DTW-1L (hazardous locations)	1 per circuit

→ **Example**

- The application is temperature maintenance (80 °F) of a pipe in a hazardous area.  
appropriate control equipment = DTW-1L

**Step 13: Determine if monitoring equipment is required:**

Monitoring increases system reliability by detecting faults before they become a major problem. Consider the following points when planning heating circuit monitoring:

- While you may select only one method of control for each trace heating circuit, you can make use of various monitoring options. The use of monitoring increases overall system reliability because failures in the heating and power distribution systems get reported to operations personnel.
- BARTEC recommends to always use, at a minimum, ground-fault monitoring. For the small additional cost, you get a monitoring system that reliably reports physical damage to the trace heating system, which is a common failure mode.
- For sensitive applications, add end of line monitoring with either a high profile end seal or an end of line light. The end of line light gives the most direct visual feedback on system performance.

**Conventional system layout with monitoring panel and ground fault equipment protection device**

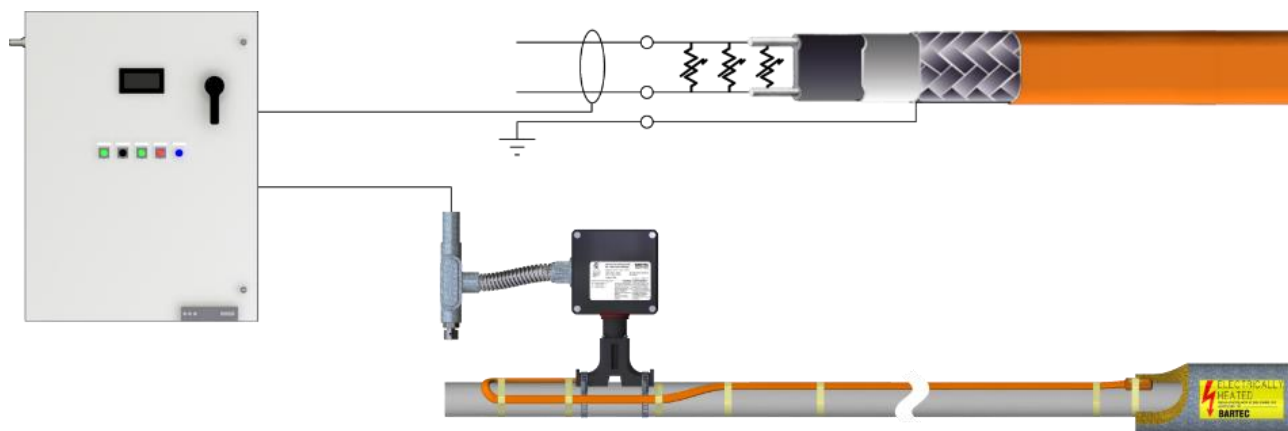

## Maintenance access through a high profile end seal

The high profile end seal is used to quickly locate the end of the heating circuit for troubleshooting in the field. It provides a convenient way to locate the end of the circuit and for testing of voltage presence at the end of the circuit.



## Continuity monitoring using an end of line light

Continuity monitoring is used to verify that the trace heater circuit has voltage present at the termination end. This is often assured by an end of line light installed as part of the end seal. In addition to the visual feedback at the end of the trace heater circuit it provides easy maintenance accessibility.



**Table K: Selecting the appropriate monitoring equipment:**

Base your selection on the number and type of trace heating circuits to be installed, the type of continuity monitoring you need, and the area classification:

TABLE K: Monitoring Equipment Selection Recommendations				
Heating circuit type	Application	Monitoring options	Suitable BARTEC monitoring product	Quantity required
Self-regulating heating circuits on pipes	Freeze protection	High profile end seal or signal light for indication	ELS-200 ELL-200	1 per circuit
Self-regulating heating circuits on pipes	Temperature maintenance or tight temperature control	High profile end seal or signal light for indication	ELS-200 ELL-200	1 per circuit

→ **Example**

- The application is temperature maintenance (80 °F) of a pipe in a hazardous area.
- The maintenance team wants to quickly be able to visually tell if the trace heating system is energized all the way to the end of the circuit.

**appropriate monitoring equipment = ELL-200**

**Step 13: Finalize the required Materials List (BOM):**

Accessories including the glass tape for attachment and pipe straps for the components and electrical traced warning labels

→ **Example**

- Heating cable catalog no. (see Step 1-5 beginning on page 5) and required length (see Step 9 on page 14) = **10PSB2-CT 125 ft**
- Heating circuit with 1 power connection kit (see Step 11 on page 16) = **PBS-200-A 1 pc.**
- Temperature maintenance in a hazardous area (see Step 12 on page 16) = **DTW-1L 1 pc.**
- Simple monitoring of the individual circuits (see Step 12 on page 16) = **ELL-200 1 pc.**
- Accessories (see section *Accessories* on page 26-30):
  - Glass cloth tape (see selection table in section *Accessories*) **GT-108 2 rolls**
  - Pipe straps (see selection table in section *Accessories*) **PC-01 4 pcs.**
  - Electrically traced warning labels **HTWL-EN 10 pcs.**

The following figure shows a sample heating circuit including typical components:

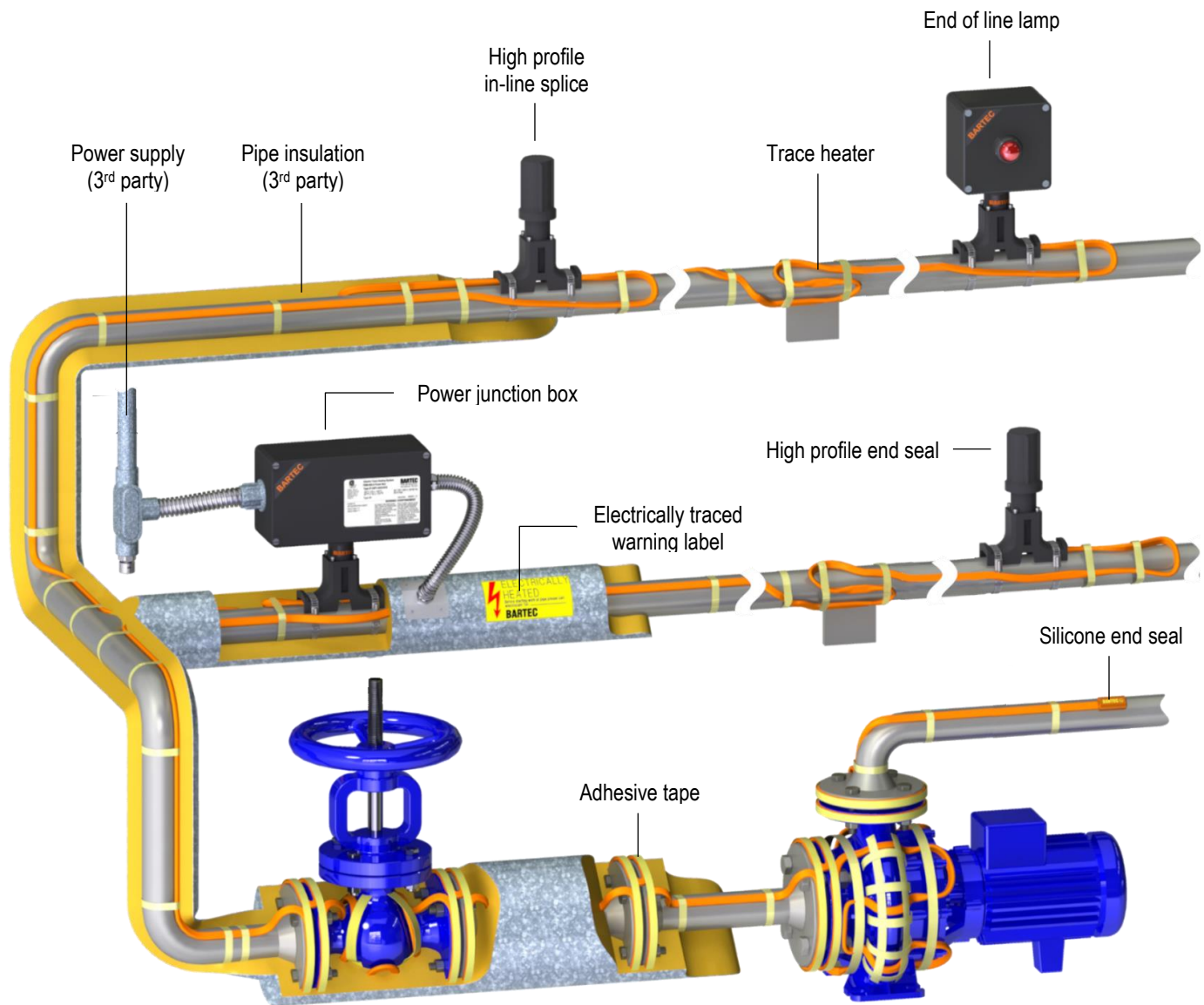

The following pages list all compatible components for BARTEC Self-regulating trace heating systems in hazardous locations. The respective installation instructions are included in the scope of delivery.

Trace heaters				
	<b>PSB trace heater with polyolefin outer jacket</b> Self-regulating trace heater for installation on pipes, tanks etc. <i>Polyolefin outer jacket: suitable for exposure to aqueous chemicals</i> Approved for Class I, II and III Div 2 areas	120 Vac 3 W/ft 5 W/ft 8 W/ft 10 W/ft	<i>Catalog No.:</i> 3PSB1-CR 5PSB1-CR 8PSB1-CR 10PSB1-CR	<i>Order No.:</i> 439493 439494 439495 439496
		120 Vac 3 W/ft 5 W/ft 8 W/ft 10 W/ft	<i>Part No.:</i> 07-5853-110P 07-5853-115P 07-5853-125P 07-5853-133P	
		240 Vac 3 W/ft 5 W/ft 8 W/ft 10 W/ft	<i>Catalog No.:</i> 3PSB2-CR 5PSB2-CR 8PSB2-CR 10PSB2-CR	<i>Order No.:</i> 439497 439498 439499 439500
		240 Vac 3 W/ft 5 W/ft 8 W/ft 10 W/ft	<i>Part No.:</i> 07-5853-710P 07-5853-715P 07-5853-725P 07-5853-733P	

	<b>PSB trace heater with fluoropolymer outer jacket</b> Self-regulating trace heater for installation on pipes, tanks etc. <i>Fluoropolymer outer jacket: suitable for exposure to organic chemicals</i> Approved for Class I, II and III Div 2 areas	120 Vac 3 W/ft 5 W/ft 8 W/ft 10 W/ft	<i>Catalog No.:</i> 3PSB1-CT 5PSB1-CT 8PSB1-CT 10PSB1-CT	<i>Order No.:</i> 439501 439502 439503 439504
		120 Vac 3 W/ft 5 W/ft 8 W/ft 10 W/ft	<i>Part No.:</i> 07-5853-110F 07-5853-115F 07-5853-125F 07-5853-133F	
		240 Vac 3 W/ft 5 W/ft 8 W/ft 10 W/ft	<i>Catalog No.:</i> 3PSB2-CT 5PSB2-CT 8PSB2-CT 10PSB2-CT	<i>Order No.:</i> 439505 439506 439507 439508
		240 Vac 3 W/ft 5 W/ft 8 W/ft 10 W/ft	<i>Part No.:</i> 07-5853-710F 07-5853-715F 07-5853-725F 07-5853-733F	

	<b>MSB trace heater</b> Self-regulating trace heater for installation on pipes, tanks etc. <i>Fluoropolymer outer jacket: suitable for exposure to organic chemicals</i> Approved for Class I, II and III Div 2 areas	120 Vac 5 W/ft 10 W/ft 15 W/ft 20 W/ft	<i>Catalog No.:</i> 5MSB1-CT 10MSB1-CT 15MSB1-CT 20MSB1-CT	<i>Order No.:</i> 439510 439511 439512 439513
		120 Vac 5 W/ft 10 W/ft 15 W/ft 20 W/ft	<i>Part No.:</i> 07-5854-115F 07-5854-130F 07-5854-145F 07-5854-160F	
		240 Vac 5 W/ft 10 W/ft 15 W/ft 20 W/ft	<i>Catalog No.:</i> 5MSB2-CT 10MSB2-CT 15MSB2-CT 20MSB2-CT	<i>Order No.:</i> 439515 439516 439517 439518
		240 Vac 5 W/ft 10 W/ft 15 W/ft 20 W/ft	<i>Part No.:</i> 07-5854-715F 07-5854-730F 07-5854-745F 07-5854-760F	



	<b>HSB trace heater</b> Self-regulating trace heater for installation on pipes, tanks etc. <i>Fluoropolymer outer jacket: suitable for exposure to organic chemicals</i> Approved for Class I, II and III Div 2 areas	<b>120 Vac</b> 5 W/ft 10 W/ft 15 W/ft 20 W/ft	<b>Catalog No.:</b> 5HSB1-CT 10HSB1-CT 15HSB1-CT 20HSB1-CT	<b>Order No.:</b> 441874 441876 441877 441878	<b>Part No.:</b> 07-5803-115A_NA 07-5803-130A_NA 07-5803-145A_NA 07-5803-160A_NA
		<b>240 Vac</b> 5 W/ft 10 W/ft 15 W/ft 20 W/ft	<b>Catalog No.:</b> 5HSB2-CT 10HSB2-CT 15HSB2-CT 20HSB2-CT	<b>Order No.:</b> 441880 441882 441883 441884	<b>Part No.:</b> 07-5803-215A_NA 07-5803-230A_NA 07-5803-245A_NA 07-5803-260A_NA

**Power connection, splice and junction components**

	<b>PBS-200-A/A10 Single power entry junction box</b> For connection of a trace heater inside a junction box. Includes a mounting stand for on-pipe installation and a silicone end seal. The kit is approved for Class I, II and III Div 2 areas. <i>Maximum power conductor size:</i> PBS-200-A 10 AWG (6 mm <sup>2</sup> ) PBS-200-A10 6 AWG (10 mm <sup>2</sup> ) 2 pipe straps per stand required. For a complete list of kit contents and approvals see data sheet.	<b>PBS-200-A:</b> Catalog No.: PBS-200-A Order No.: 407400 Part No.: 27-54P1-4212/1610 <b>PBS-200-A10:</b> Catalog No.: PBS-200-A10 Order No.: 419868 Part No.: 27-54P1-4312/3710
--	--	--

	<b>PBS-300-A/A10 Single power entry junction box</b> For connection of a trace heater inside a junction box. Includes a mounting stand for off-pipe installation and a silicone end seal. The kit is approved for Class I, II and III Div 2 areas. <i>Maximum power conductor size:</i> PBS-300-A 10 AWG (6 mm <sup>2</sup> ) PBS-300-A10 6 AWG (10 mm <sup>2</sup> ) 2 pipe straps per stand required. For a complete list of kit contents and approvals see data sheet.	<b>PBS-300-A:</b> Catalog No.: PBS-300-A Order No.: 407401 Part No.: 27-54P1-4211/1670 <b>PBS-300-A10</b> Catalog No.: PBS-300-A10 Order No.: 419868 Part No.: 27-54P1-4431/1611
---	---	---



**PBM-200-A Multiple power entry junction box**

For connection of up to 3 trace heaters inside a junction box. Includes a mounting stand for on-pipe installation and 3 silicone end seals. The kit is approved for Class I, II and III Div 2 areas.

*2 pipe straps per stand required.  
For a complete list of kit contents and approvals see data sheet.*

Catalog No.: PBM-200-A  
Order No.: 407402  
Part No.: 27-54P1-4433/1610

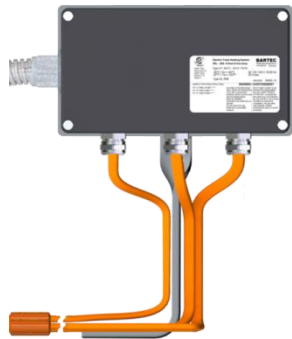

**PBM-300-A Multiple power entry junction box**

For connection of up to 3 trace heaters inside a junction box. Includes a mounting stand for off-pipe installation and 3 silicone end seals. The kit is approved for Class I, II and III Div 2 areas.

*2 pipe straps per stand required.  
For a complete list of kit contents and approvals see data sheet.*

Catalog No.: PBM-300-A  
Order No.: 407404  
Part No.: 27-54P1-4431/1610

**Control and monitoring units**



**Mechanical thermostats for ordinary locations**

Mechanical thermostat with fixed set point at 40 °F / 5 °C. The TYPE 4X enclosure is coated cast aluminum with stainless steel hardware. The SPDT switch is rated 480 Vac / 22 A. The stainless steel sensor assembly is 9 ft. (3 m) in length. The unit is UL Listed and CSA certified for use in nonhazardous locations. Select this thermostat where set point adjustment or mechanical ruggedness are important.

Catalog No.: BMC-1A  
Order No.: 710110



### Mechanical thermostats for hazardous locations

This is the hazardous location-approved version of the BMC-1A. It includes a TYPE 4, 7, 9 coated cast-aluminum enclosure and is approved by FM, UL Listed, and CSA certified for use in Div 1 and 2 hazardous locations. Select this thermostat when the control unit must be located in a hazardous location and mechanical ruggedness is important.

*Set point:*

*DTW-1A fixed set point (40 °F / 5 °C)*

*DTW-1L adjustable set point: (25-325 °F / -4-163 °C)*

*DTW-1A:*

Catalog No.: DTW-1A  
Order No.: 710146  
Part No.: 27-6CB5-2410/2000

*DTW-1L:*

Catalog No.: DTW-1L  
Order No.: 710147  
Part No.: 27-6CA5-2411/2000

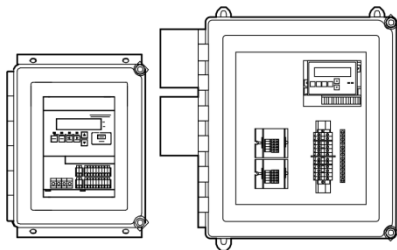

### BARTEC TraceMate & BARTEC TraceMate II

The BARTEC TraceMate single-point controller / TraceMate II dual-point controller sense pipe or tank temperatures to provide tight temperature control for process applications. They also feature continuous monitoring technology to detect trace heating faults, monitor trace heating current and provide networking capabilities. The integral ground-fault protection eliminates the need to install ground-fault circuit breakers.

*The TraceMate and TraceMate II are CSA certified (U.S. and Canada) for use in nonhazardous or Zone 2 hazardous locations.*

*TraceMate*

Catalog No.: TraceMate  
Order No.: 710118

*TraceMate II*

Catalog No.: TraceMate II-CTR  
Order No.: 710121

## End termination



### ELL-200 End of line lamp

End of line lamp for connection of a trace heater. Includes a mounting stand for on-pipe installation. The kit is approved for Class I, II and III Div 2 areas.

*2 pipe straps per stand required.*

*For a complete list of kit contents and approvals see data sheet.*

Catalog No.: ELL-200  
Order No.: 407405  
Part No.: 27-54E1-4212F010



**ELL-300 End of line lamp**

End of line lamp for connection of a trace heater. Includes a mounting stand for off-pipe installation. The kit is approved for Class I, II and III Div 2 areas.

*2 pipe straps per stand required.  
For a complete list of kit contents and approvals see data sheet.*

Catalog No.: ELL-300  
Order No.: 407406  
Part No.: 27-54E1-4211F010



**CAK-E5/E10 Cold applied end seal**

Silicone end seal for insulation of the end of the trace heater.

CAK-E5 5 pcs.  
CAK-E10 10 pcs.

*For a complete list of kit contents and approvals see data sheet.*

**CAK-E5:**  
Catalog No.: CAK-E5  
Order No.: 404126  
Part No.: 27-59CZ-90000001

**CAK-E10:**  
Catalog No.: CAK-E10  
Order No.: 404128  
Part No.: 27-59CZ-90000010



**ELS-200 high profile end seal**

End seal for access above the insulation. The kit is approved for Class I, II and III Div 2 areas.

*2 pipe straps per stand required.  
For a complete list of kit contents and approvals see data sheet.*

Catalog No.: ELS-200  
Order No.: 710256  
Part No.: 27-54E1-7A27/0000

**Accessories**

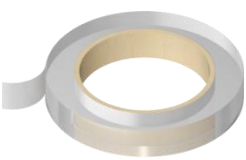

**Polyester adhesive tape**

for use on pipes other than stainless steel

*3/4" x 164 ft (50 m) per roll  
Minimum installation temperature (dry surface): 40 °F (5 °C)  
Maximum withstand temperature: 212 °F (100 °C)*

Catalog No.: PT-164  
Order No.: 100706  
Part No.: 02-5500-0005

Tip: Refer to the following table to estimate the required number of tape rolls for your installation:

Pipe diameter in inch (DN)	1/4" (DN8)	1/2" (DN15)	3/4" (DN20)	1" (DN25)	1 1/4" (DN32)	1 1/2" (DN40)	2" (DN50)	2 1/2" (DN65)	3" (DN80)	4" (DN100)	6" (DN150)	8" (DN200)	10" (DN250)	12" (DN300)	14" (DN350)	16" (DN400)	18" (DN450)	20" (DN500)	24" (DN600)
Required no. of tape rolls per 100 ft (30 m) of piping	1	1	1	1	1	1	2	2	2	3	4	5	6	7	7	8	9	10	12

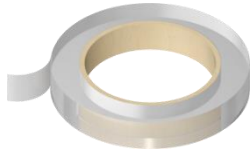

### Glass cloth tape

for fixation of self-regulating trace heaters on all pipes including stainless steel / required during preparation of power limiting trace heaters

1/2" x 108 ft (33 m) per roll

Minimum installation temperature (dry surface): 15 °F (-10 °C)  
Maximum withstand temperature: 392 °F (200 °C)

Catalog No.: GT-108  
Order No.: 100306  
Part No.: 02-5500-0047

Tip: Refer to the following table to estimate the required number of tape rolls for your installation (for fixation of trace heaters on pipes only)

Pipe diameter in inch (DN)	1/4" (DN8)	1/2" (DN15)	3/4" (DN20)	1" (DN25)	1 1/4" (DN32)	1 1/2" (DN40)	2" (DN50)	2 1/2" (DN65)	3" (DN80)	4" (DN100)	6" (DN150)	8" (DN200)	10" (DN250)	12" (DN300)	14" (DN350)	16" (DN400)	18" (DN450)	20" (DN500)	24" (DN600)
Required no. of tape rolls per 100 ft (30 m) of piping	1	1	1	1	2	2	2	3	3	4	5	7	9	10	11	12	14	15	18

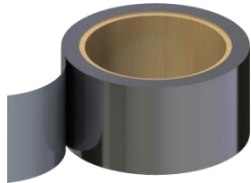

### Aluminum adhesive tape

for use on all pipe materials

2" x 164 ft (50 m) per roll

AT80:

Minimum installation temperature (dry surface): 40 °F (5 °C)  
Maximum withstand temperature: 176 °F (80 °C)

AT150:

Minimum installation temperature (dry surface): 40 °F (5 °C)  
Maximum withstand temperature: 302 °F (150 °C)

Tip: The required number of tape rolls per 100 ft (30 m) of pipe is 0.6.

AT80:

Catalog No.: AT80-164  
Order No.: 100506  
Part No.: 02-5500-0003

AT150:

Catalog No.: AT150-164  
Order No.: 101606  
Part No.: 02-5500-0014



### Stainless steel pipe straps

stainless steel, for fixation of mounting stands on pipes etc. No special tooling required.

for pipe ø up to 3" / DN80:

Catalog No.: PC-1  
Order No.: 710144

for pipe ø up to 10" / DN250:

Catalog No.: PC-2  
Order No.: 710145

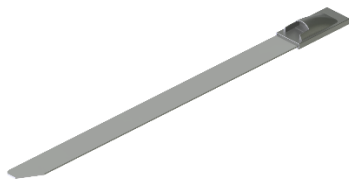

### Stainless steel cable ties

for installation of power limiting trace heaters, mounting stands, etc.

SSC-03: pipe ø up to 3" / DN80

SSC-06: pipe ø up to 6" / DN150

Pack of 100 pcs.

SSC-03:

Catalog No.: SSC-03  
Order No.: 126227  
Part No.: 03-6510-0208

SSC-06:

Catalog No.: SSC-06  
Order No.: 126228  
Part No.: 03-6510-0209

	<p><b>Insulation entry bushing</b></p> <p>for protection of trace heaters or sensor cables at the point where they pass through the thermal insulation outer cladding</p>	<p>for PSB trace heaters:</p> <p>Catalog No.: IEB-P Order No.: 234006 Part No.: 05-0020-0472</p> <p>for HSB trace heaters:</p> <p>Catalog No.: IEB-H Order No.: 106730 Part No.: 05-0020-0091</p> <p>for PT100 sensor:</p> <p>Catalog No.: IEB-PT Order No.: 122964 Part No.: 05-0020-0261</p>
---	---	--

	<p><b>Electrically traced warning label</b></p> <p>Warning label for trace heater circuits</p> <p><i>Recommended: electrical warning label every 10 ft. (3 m) on the outside of the thermal cladding on a clearly visible place.</i></p> <p><i>Packaged in rolls of 100 pieces per roll</i></p>	<p>English:</p> <p>Catalog No.: HTWL-US Order No.: 113550 Part No.: 05-2144-0047</p> <p>French:</p> <p>Catalog No.: HTWL-FR Order No.: 120300 Part No.: 05-2144-0703</p>
---	---	--

	<p><b>Polyester fixing straps</b></p> <p>for installation of trace heaters on tanks and vessels</p> <p><i>for tank diameters up to 10"</i></p> <p><i>3/4" x 2790 ft. (850 m) on full roll</i></p>	<p>Catalog No.: PFS-850 Order No.: 117932 Part No.: 03-6500-0100</p>
---	---	--

	<p><b>Tensioning buckle</b></p> <p>for use with the PFS-850 polyester fixing straps</p>	<p>Catalog No.: TB-075 Order No.: 117939 Part No.: 03-6515-0203</p>
---	---	---

## Spare parts



### Hazardous Area 100 Ohm Platinum RTD

Platinum RTD mounted inside a 316SS sheath and includes a 3/4" radius mounting pad with an Aluminum head assembly.

*BRTD-D2 has a NEMA Type 4x Aluminum head, 900 °F, Class I, Division 2 rated*

*BRTD-D1 has a NEMA Type 7 Aluminum head, 900 °F, Class I, Division 1 rated*

**BRTD-D2:**

Catalog No.: BRTD-D2  
Order No.: 710148

**BRTD-D1:**

Catalog No.: BRTD-D1  
Order No.: 710149



### On pipe cable gland kit and end seal

Spare parts kit for use with PBS/PBM-200 kits for replacement of damaged or lost parts.

Catalog No.: CAK-D5  
Order No.: 404122  
Part No.: 27-59CZ-7C010001



### On pipe cable gland kit and end seal

Spare parts kit for use with PBS/PBM-200 kits for replacement of damaged or lost parts (On-pipe power boxes with pedestal PS-120).

Catalog No.: CAK-SRS  
Order No.: 434968  
Part No.: 27-59CX-7C01/0001

	<p><b>Off pipe cable gland kit and end seal</b></p> <p>Spare parts kit for use with PBS/PBM-300 kits for replacement of damaged or lost parts.</p>	<p>Catalog No.: CAK-PH                  Order No.: 404078                  Part No.: 27-59CZ-73010001</p>
---	--	---

	<p><b>Splice adaptor kit</b></p> <p>provides the additional parts to use the PBS-200 kits as an above the insulation splice kit</p>	<p>Catalog No.: CAK-M25                  Order No.: 710258                  Part No.: 27-59CZ-9901/0001</p>
---	---	---

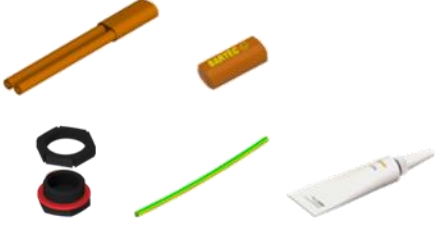
	<p><b>Splice adaptor kit</b></p> <p>Provides the additional parts to use the PBS/PBM junction boxes as an above the insulation splice kit (On-pipe power boxes with pedestal PS-120).</p> <p>For standard need:                  PBS/PBM-*-E provides M25x1.5 entry</p>	<p>Catalog No.: CAK-M25                  Part No.: 27-59CX-0G01/0001</p>
---	---	--

**Installation**

**Preparation**

Before installing any electric trace heating, the person installing must check if the trace heating has been designed and planned correctly. It is particularly essential to verify the following points:

- complete project planning documentation, operating instructions and installation instructions.
- correct selection of the trace heater and accessories with respect to:
  - calculation of heat losses
  - max. permissible operating temperature
  - max. permissible ambient temperature
  - temperature class
  - heating circuit length

Before installing, make sure that all piping and equipment is properly installed and pressure tested.



## Required tools / equipment

The following tools are required for installation of the BARTEC Self-regulating trace heating systems:

- Wire cutters
- Insulation resistance meter with a minimum testing voltage of 500 Vdc and a maximum testing voltage of 2500 Vdc.



1

## Unrolling the trace heater

### ⚠ WARNING

Risk of short circuit and/or material damage. Keep the trace heater ends dry before and during installation.

- Unroll the required trace heater in a straight line and cut to the correct length. Cut off the trace heater ensuring a straight cut.
- Do not bend or pinch the trace heater, or pull it over sharp edges.

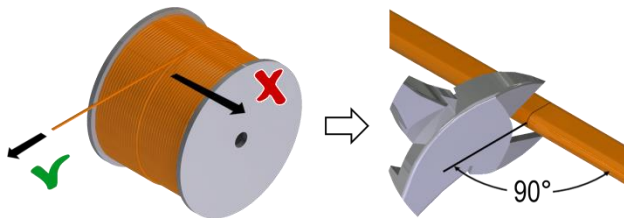

2

## Installation on pipes

This step is necessary for plastic pipes only since plastic pipes conduct heat less efficiently than metal pipes do. For metal pipes continue with step 4.

- Place aluminium tape (see section *Accessories* on page 26) where the trace heater will be attached for better heat distribution.



3

### ⚠ CAUTION

Risk of injury and/or material damage. Never step on or drive over the trace heater. Do not use it as a loop for stepping on.

- Install the trace heater in a straight line along the pipe. This saves time, helps to avoid installation mistakes and prevents damage to the trace heater during the thermal insulation work.



4

- Preferably install the trace heater in the lower half of the pipe, but **not on the lowest point**. This prevents mechanical damage and allows for better heat distribution.
- If you use multiple trace heaters, position them with an offset of 90°.

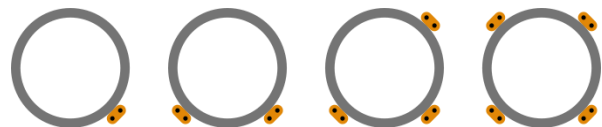

5

**Fastening**

Select the correct fastening material:

- Use polyester adhesive tape or glass cloth tape that suits the expected temperatures.
- Preferably use BARTEC adhesive tapes.
- Never use PVC electrical tape or self-adhesive tapes containing PVC or VC.
- Do not use metal wire or banding.



6

- Fasten the trace heater with the adhesive tape at intervals of a maximum of 12" (300 mm) on plastic pipes or 36" (900 mm) on steel pipes.

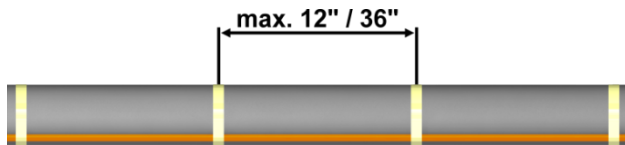

**NOTICE**

In order to ensure good heat transfer the trace heater should have a flat, flush fit over the whole length. If necessary, reduce the distances between the fixing points.

7

- Apply the pipe's insulation according to the manufacturer's installation instructions.
- Apply an electrical warning label every 10 ft. (3 m) on a clearly visible place.

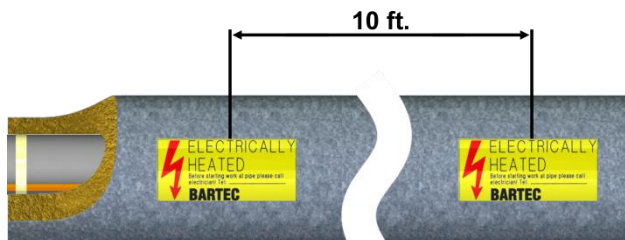

8

**Trace heater routing**

- On fittings, valves etc. you should leave a sufficiently large trace heater loop to ensure that the equipment is easily accessible. This way, heating circuits do not have to be cut up for maintenance or replacement works.
- Due to the higher heat losses from fittings, valves, flanges etc. an additional length of trace heater is required. This requirement is specified in the project planning documents.
- The following illustrations show typical types of installation.

**NOTICE**

The bending radius of the trace heater must always be at least 1" (25 mm). Do not bend on the narrow axis.

9

- Installation on bends:

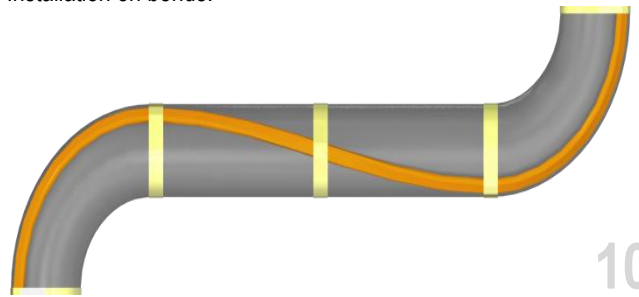

10

- Installation of service loops on components:



11

- Installation on valves:

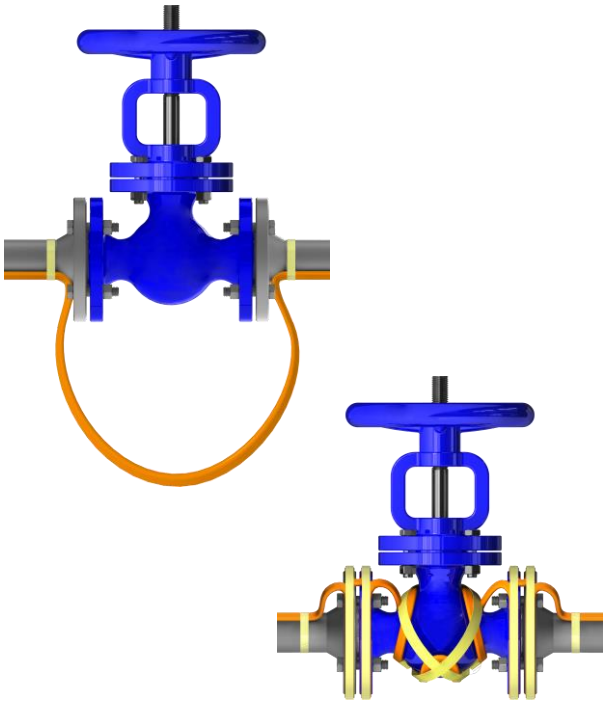

12

- Installation on flanges:

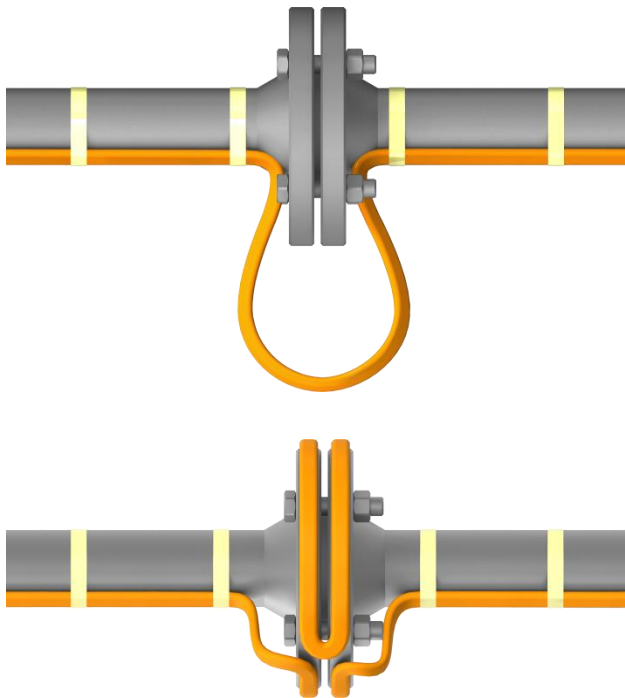

13

- Installation on pipe supports:

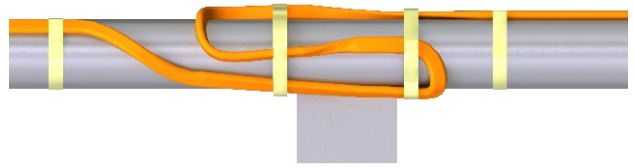

14

- Installation on pressure gauges:

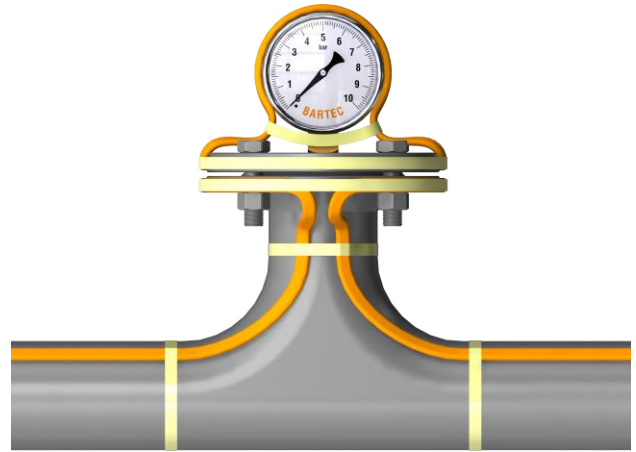

15

- Installation on pumps:

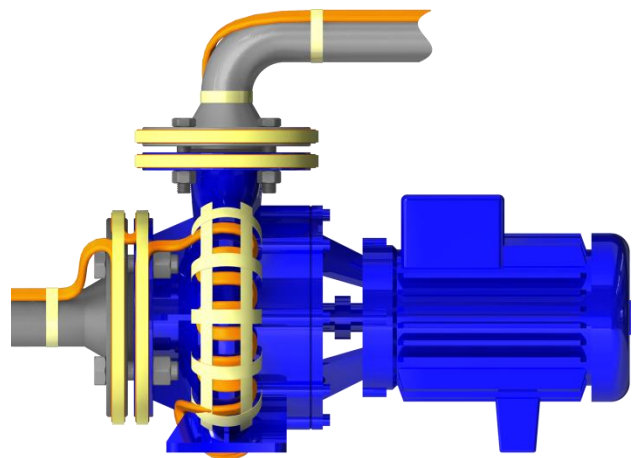

16

Installation on tanks and vessels

- For tank diameters of up to 6.5 ft (2 m) the trace heater is attached using polyester fixing straps and tensioning buckles (see section *Accessories* on page 26).



- To fasten the fixing straps thread the polyester straps through the tensioning buckle as shown and pull the ends of the straps.

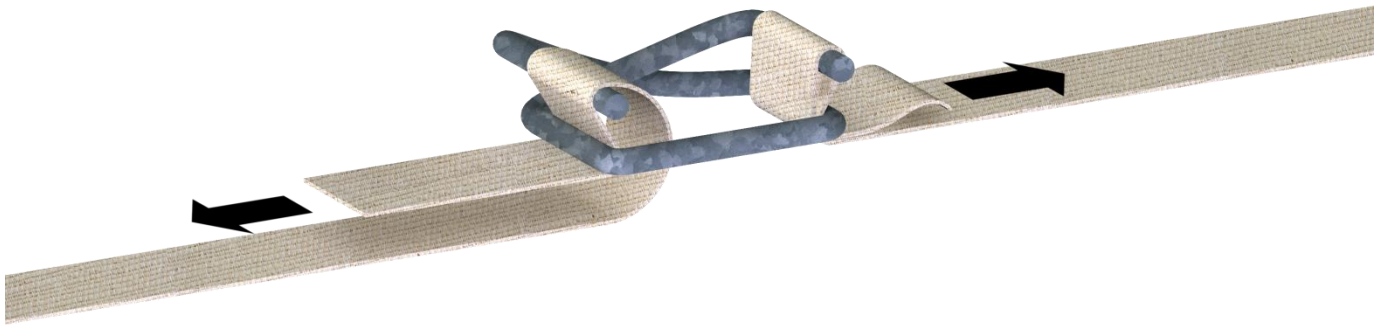

- At first, install fixing straps around the beginning and end of the tank and fasten them with slight tension.

Upright tank



Horizontal tank



- Install the trace heater beginning at the supply point.
- Fix it at the distances specified in the project planning documentation. Use the pre-mounted fixing straps to hold the trace heaters in place.
- Allow for material addition for the bases.

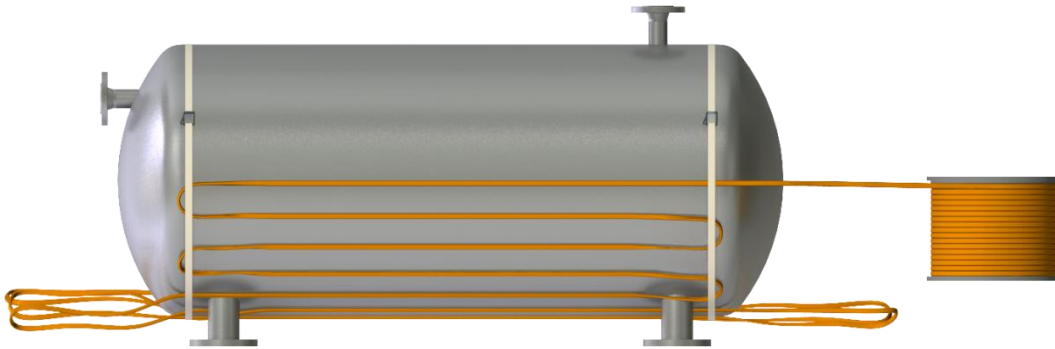

19

- Align the trace heater exactly and fix it firmly to the bases and the cylinder using additional fixing straps.
- To avoid damage to the trace heater, make sure that the fixing straps are not tightened too firmly. It should be possible to move the trace heater slightly under the fixing straps.
- The distances between the fixing straps should not exceed 10" (250 mm).

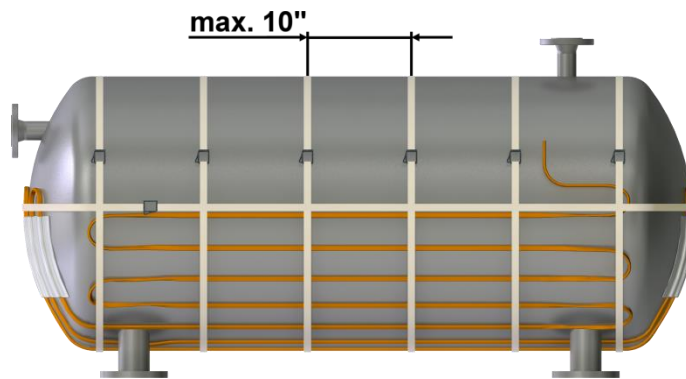

20

- Finally, place aluminium tape on areas of loose contact of the trace heater.
- This step improves heat transfer and prevents insulating material being trapped between the trace heater and the tank.



21

**Tests and commissioning**

**Measurement of the insulation resistance**

The measurement of the insulation resistance is used to determine damage to the trace heater and possible installation faults. It must be carried out at the following times:

- Preliminary test (on the reel, before installation of the trace heater on the construction site; refer to section *Acceptance Report* on page 40)
- Acceptance test (after installation of the heating circuit and before installation of the thermal insulation; refer to section *Acceptance Report* on page 40)
- Final inspection (immediately after completion of work on the thermal insulation)
- Upon commissioning
- Before switching on the installation

**Preparation of the measurement:**

- De-energize the heating circuit.
- Disconnect the thermostat or controller, if installed.
- Disconnect the bus wires and PE wires from the terminal block, if installed.
- For the measurement you will need a megohmmeter with, at least, a minimum testing voltage of 500 Vdc and a maximum testing voltage of 2500 Vdc.

**Test 1 - Conducting the measurement between the bus wires and the grounding braid:**

- Set the test voltage to 0 Vdc.
- Connect the negative (-) lead to the grounding braid of the trace heater.
- Connect the positive (+) lead to both trace heater bus wires simultaneously.
- Turn on the megohmmeter and set the voltage to 500 Vdc.
- Apply the voltage for 1 minute. The meter reading should stabilize. Rapid changes in the reading indicate a breakdown of the insulation.
- Record the insulation resistance value in the Inspection Record.
- Repeat the measurement at 1000 and 2500 Vdc.

**Test 2 - Conducting the measurement between the grounding braid and PE:**

- Repeat the measurement between the grounding braid and PE (again, at 500, 1000 and 2500 Vdc).

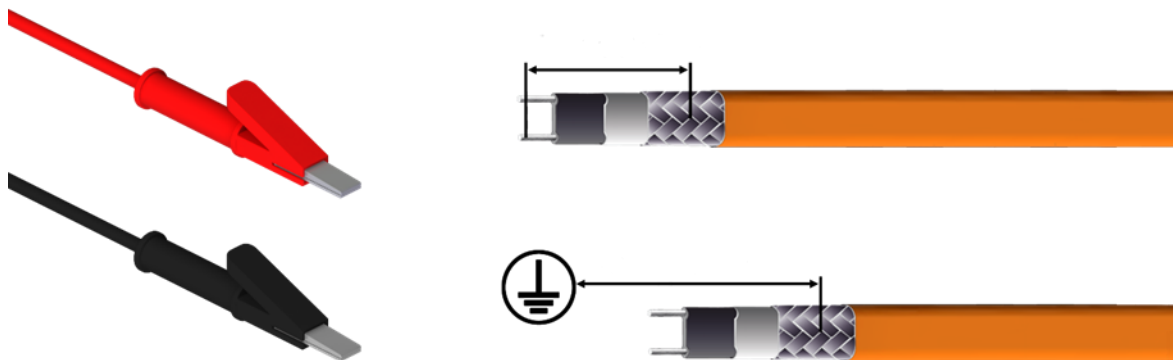

**Results:**

- Properly installed dry and clean trace heater sets should measure thousands of megohms, regardless of the trace heater length or measuring voltage (0-2500 Vdc). The following guidance is provided to assist in determining the acceptability of an installation where optimum conditions may not apply. All insulation resistance values should be greater than 1000 megohms. If the reading is lower or fluctuating, refer to section *Troubleshooting* on page 39.
- Insulation resistance values for Test 1 and 2; for any particular circuit, should not vary more than 25 percent as a function of measuring voltage. Greater variances may indicate a problem with your trace heating system; confirm proper installation and/or contact your local BARTEC representative for assistance.

**⚠ WARNING**  
 Risk of fire or electrical shock. If the insulation resistance is insufficient you must fix the heating circuit before putting it into operation.

**After the measurement:**

If trace heater meets all resistance criteria:

- Reconnect the bus wires.
- Reconnect any thermostat or controller.
- Reenergize the circuit.

## Acceptance test and acceptance test report

- After completion of the installation work (before installation of the thermal insulation) each heating circuit must be accepted, if possible in the presence of the client.
- All further tests must also be documented in an acceptance test report (refer to section *Acceptance report / Record of inspection* on page 40).

## NOTICE

**Claims under warranty will not be considered if the acceptance report is not filled in completely.**

- After completion of work on the thermal insulation final inspection and acceptance of the individual heating circuits is recommended. Usually, this is the task of the client or the final customer (= final inspection).

## Commissioning

Each heat tracing system can only be put into operation if the following conditions are fulfilled:

- The acceptance test reports for each heating circuit are complete and the trace heating system has been accepted.
- All components of the heating circuit are completely installed and are in working order.
- It has been ensured that the heating circuit is operated in conformance with the technical data specified by BARTEC.

## NOTICE

**Upon a cold start, additional heating power is required for heating up tanks and pipes. When starting the system you should allow sufficient time for heat up. For further information on heat up calculations contact your local BARTEC representative.**

## Operation

During operation of the electric trace heating system you must ensure that all components of the system are operated within the operating data specified by BARTEC.

This applies particularly to observation of the maximum temperature. Operation within these operating data is a precondition for possible later warranty claims.

## System documentation

Complete documentation must be carried out for each system, from the project planning stage, through installation and commissioning up to periodic maintenance of the trace heating system.

This documentation should include the following:

- Project planning documents
- Manuals of all of the components of the heating system
- Heat loss calculation
- Selection of the trace heater
- Layout plans with division of heating circuits
- Circuit graphs
- Acceptance reports
- Reports on repairwork and any operations carried out on the tank/pipe system, trace heating system and thermal insulation
- Inspection reports

## Maintenance

### Visual and functional inspection

- Regularly check the thermal insulation for possible damage, missing seals, cracks, damage to the outer jacket, missing thermal insulation bushings for trace heaters and cables, penetrated water or chemicals. If the thermal insulation is damaged the trace heater should be checked for possible damage.
- Damaged trace heaters must be replaced.
- Parts subject to wear must be replaced (e.g. seals, locking plates etc).
- Check junction boxes, splices, end terminations etc. for corrosion and possible mechanical damage. Make sure that all enclosure covers are properly in place.
- If present, check the temperature controller connecting cables and sensors for damage and that their installation is protected against mechanical damage.

## Electrical inspection

- Measurement of the insulation resistance should be seen as a permanent part of regular maintenance. For instructions on how to perform the test refer to section *Measurement of the insulation resistance* on page 36.

## Inspection intervals

- For frost protection installations inspections should be carried out annually before the heating period begins.
- For systems designed to maintain process temperatures, inspections should be carried out at regular intervals, but at least twice a year.

## Personnel training courses

- Regular maintenance should be carried out by trained, experienced maintenance personnel.
- It is recommended that maintenance personnel is updated on new developments in application technology and maintenance.

## Repairwork on piping or thermal insulation

- Ensure that all safety procedures and precautions in the area for repairs are followed.
- Take care that the heat tracing system is not damaged during repairwork on the pipes or insulation.
- After completion of the repairwork:
  - Make sure that any repaired heating circuits are properly installed and tested according to the project planning documentation.

## **WARNING**

**Risk of fire or electrical shock due to damaged components. Remember that self-regulating trace heaters are designed to be installed only once.**

- Carry out a visual, functional and electrical test (refer to section *Tests and commissioning* on page 36).



## Troubleshooting

Problem	Possible cause	Remedy
Trace heater remains cold	No power supply	Check the power wiring for continuity to circuit breaker.
	Trace heater bus wires or power wiring not properly connected	Connect the trace heater and power wires according to the installation instructions.
	Control unit adjusted incorrectly	Adjust the control unit according to the installation instructions.
Automatic circuit breaker tripped	Automatic circuit breaker defective	Replace the automatic circuit breaker.
	Automatic circuit breaker has wrong tripping characteristics, e. g. "B" instead of "C"	Install an automatic circuit breaker with Type-C tripping characteristics or contact the factory for Type-B tripping characteristics.
	Nominal circuit breaker size is insufficient	Install an automatic circuit breaker with higher capacity. Observe the maximum amperage of all components of the trace heating circuit.
	Maximum heating circuit length has been exceeded	Split the heating circuit into separate circuits.
	End seal has not been installed	Install the end seal according to the installation instructions.
	Short circuit	Identify the cause and remedy the fault (e. g. ensure that trace heater bus wires are not twisted together).
	Humidity inside the connection system or end seal	Dry the components. For junction boxes, be sure that the conduit drain is installed and breathing properly.
Ground fault protection is disengaged	Trace heater damaged	Replace the trace heater at the point where it is damaged.
	Moisture in the components	Dry the components. For junction boxes, be sure that the conduit drain is installed and breathing properly.
	Ground fault protection defective	Replace the ground fault protection device(s).
Low or inconsistent insulation resistance	Trace heater damaged	Replace the trace heater at the point where it is damaged.
	Moisture in the components	Dry the components. For junction boxes, be sure that the conduit drain is installed and breathing properly.
	Arcing due to damaged trace heater insulation	Replace the trace heater at the point where it is damaged.
	Arcing due to inadequate stripping distance between heating element and grounding braid	Check the stripping distance between bus wires/heating element and grounding braid at all power, splice and end seal connections to ensure adequate separation.
	Short-circuit between the grounding braid and the heating element or the grounding braid and the pipe	Check for cut or damaged cable or inadequate stripping length.
	Test leads touching the junction box	Relocate test leads and retest.

*Note: High pipe temperature may lower the insulation resistance reading relative to earlier readings on a cold pipe.*

**Acceptance report / Record of inspection**

**Protocol type**

Inspection before commissioning <input type="checkbox"/>	Inspection after modification <input type="checkbox"/>	Periodic inspection <input type="checkbox"/>
Visual inspection <input type="checkbox"/>	Close inspection <input type="checkbox"/>	Detailed inspection <input type="checkbox"/>

**Project information**

Project / Customer	
Order Comm. No. / BARTEC Order No.	
Date	

**Installation details**

Heating circuit type	Electric Trace Heating of Pipes <input type="checkbox"/>	Electric Trace Heating of Tanks/Vessels <input type="checkbox"/>
Ex version	yes <input type="checkbox"/> no <input type="checkbox"/> Zone <input type="text"/>	Temperature class T <input type="checkbox"/> Ex group <input type="text"/>
Switchgear / Distribution panel	Included in the scope of delivery	UV Name ESS/LDP
	yes <input type="checkbox"/> no <input type="checkbox"/>	Test report <input type="checkbox"/>
Thermal insulation	Thermal insulation material	Thermal insulation thickness in inch <input type="text"/>
	Check <b>before</b> installation of the insulation Date / Name / Signature	Check <b>after</b> installation of the insulation Date / Name / Signature

**Heating circuit data**

Heating Circuit No.				
Sub-Heating circuit	yes <input type="checkbox"/> no <input type="checkbox"/>	yes <input type="checkbox"/> no <input type="checkbox"/>	yes <input type="checkbox"/> no <input type="checkbox"/>	yes <input type="checkbox"/> no <input type="checkbox"/>
Pipe-/Vessel No.				
Building				
Product				
Trace heater type				
Lot No. of trace heater				
Trace heater length	_____ ft. (m)	_____ ft. (m)	_____ ft. (m)	_____ ft. (m)
Serial No. connection kit				
Serial No. junction box				
Voltage	_____ V	_____ V	_____ V	_____ V
Current (Switch on / operation)	_____/____ A	_____/____ A	_____/____ A	_____/____ A
Output power trace heater	_____ W/ft. (W/m)	_____ W/ft. (W/m)	_____ W/ft. (W/m)	_____ W/ft. (W/m)
Trace heater resistance (constant wattage trace heaters only)	_____ Ω	_____ Ω	_____ Ω	_____ Ω
Insulation resistance at ..... V	> _____ MΩ	> _____ MΩ	> _____ MΩ	> _____ MΩ
Temperature settings	°F (°C) yes no	°F (°C) yes no	°F (°C) yes no	°F (°C) yes no
Controller	_____ <input type="checkbox"/> <input type="checkbox"/>	_____ <input type="checkbox"/> <input type="checkbox"/>	_____ <input type="checkbox"/> <input type="checkbox"/>	_____ <input type="checkbox"/> <input type="checkbox"/>
Limiter	_____ <input type="checkbox"/> <input type="checkbox"/>	_____ <input type="checkbox"/> <input type="checkbox"/>	_____ <input type="checkbox"/> <input type="checkbox"/>	_____ <input type="checkbox"/> <input type="checkbox"/>
Low temperature	_____ <input type="checkbox"/> <input type="checkbox"/>	_____ <input type="checkbox"/> <input type="checkbox"/>	_____ <input type="checkbox"/> <input type="checkbox"/>	_____ <input type="checkbox"/> <input type="checkbox"/>

Remarks: \_\_\_\_\_  
 \_\_\_\_\_

City/Date

BARTEC Contractor  
Name / Signature

Customer  
Name / Signature

**NOTICE**

Claims under warranty will not be considered if the acceptance report is not filled in completely.

## Limited Product warranty

### Scope

BARTEC warrants that all BARTEC products and accessories that are the subject of this manual will be free from defects in materials and workmanship from and after its date of purchase for a period of 12 (twelve) months.

For the avoidance of doubt, this limited product warranty will **not** cover any damage caused by:

- accidents,
- misuse, improper installation, operation, maintenance or repairs,
- neglect, or
- alteration.

Furthermore, BARTEC cannot be held liable under this warranty for:

- installation or removal costs,
- loss or damage to property,
- indirect, special, incidental or consequential damages (including, without limitation, loss of revenue or anticipated profits), or
- any other damages or costs directly or indirectly related to the warranty issue.

If all warranty conditions are met (as set forth below), BARTEC will, at its sole discretion:

- repair the product,
- replace the product, or
- refund the purchase price paid for the product.

This warranty gives you specific legal rights, and you may also have other rights which vary by country, state or province. Except as specifically provided otherwise in this limited product warranty, the BARTEC Group General Terms and Conditions shall apply.

### General terms and conditions

BARTEC Global Terms and conditions are available at: <https://www.bartec.de/en/terms/>

### Conditions

The limited product warranty is subject to the following conditions:

- proper installation, operation and maintenance in compliance with the state of the technology and the product documentation, and
- presence of completely filled in acceptance reports for all installation, maintenance and repairwork operations.

### How to claim the warranty

To file a claim under the limited product warranty:

- Notify BARTEC or your local BARTEC representative by written correspondence or email within 30 days after identification of a possible warranty issue.
- If requested, you must provide any warranty-related information and documentation to BARTEC, including, without limitation:
  - project planning documents, and
  - acceptance reports for installation, operation, maintenance or repairwork.

**BARTEC US**  
650 Century Plaza Drive, Suite D120  
Houston, Texas 77073  
USA

Phone: +1 281 214-8542  
Fax: +1 281 214-8547  
sales@bartec.us  
www.bartec.us

**BARTEC GmbH**  
Max-Eyth-Straße 16  
97980 Bad Mergentheim  
Germany

Phone: +49 7931 597-0  
Fax: +49 7931 597-499  
info@bartec.com  
www.bartec.com